

# **FURUNO**

## **OPERATOR'S MANUAL**

*INMARSAT FLEETBROADBAND  
SHIP EARTH STATION*

**FELCOM250**

Model

**FELCOM500**

---

**ECF**

(Elemental Chlorine Free)

The paper used in this manual  
is elemental chlorine free.

**FURUNO ELECTRIC CO., LTD.**

9-52 Ashihara-cho,  
Nishinomiya, 662-8580, JAPAN

• FURUNO Authorized Distributor/Dealer

All rights reserved. Printed in Japan

Pub. No. OME-56660-S

(TAHA ) FELCOM500/250

A : AUG. 2009

S : JUN. 13, 2017



0 0 0 1 7 8 0 9 9 1 6

# IMPORTANT NOTICES

## General

- This manual has been authored with simplified grammar, to meet the needs of international users.
- The operator of this equipment must read and follow the descriptions in this manual. Wrong operation or maintenance can cancel the warranty or cause injury.
- Do not copy any part of this manual without written permission from FURUNO.
- If this manual is lost or worn, contact your dealer about replacement.
- The contents of this manual and equipment specifications can change without notice.
- The example screens (or illustrations) shown in this manual can be different from the screens you see on your display. The screens you see depend on your system configuration and equipment settings.
- Save this manual for future reference.
- Any modification of the equipment (including software) by persons not authorized by FURUNO will cancel the warranty.
- Windows, Internet Explorer, SmartScreen, Windows Media and Microsoft Edge are either registered trademarks or trademarks of the Microsoft Corporation in the United States and/or other countries.
- Quick Time is a trademark of Apple Inc.
- Mozilla and FireFox are registered trademarks or trademarks of Mozilla Foundation.
- Real Player is a registered trademark or trademark of RealNetworks, Inc.
- The following concern acts as our importer in Europe, as defined in DECISION No 768/2008/EC.
  - Name: FURUNO EUROPE B.V.
  - Address: Ridderhaven 19B, 2984 BT Ridderkerk, The Netherlands
- All brand and product names are trademarks, registered trademarks or service marks of their respective holders.
- "MV", "Multi voice", "Alternative MSISDN" and "FX" require a contract with their respective providers. If you do not have a contract for Fleet Express or Multi voice, disable the FX mode or Multi-voice function.
  - MV/Multi voice: Multi-voice service
  - Alternative MSISDN: Multi MS-ISDN service
  - FX: Fleet Xpress service
- When FX mode is active, PS connection/disconnection from devices such as handsets or PCs with Launchpad installed is not possible.

## How to discard this product

Discard this product according to local regulations for the disposal of industrial waste. For disposal in the USA, see the homepage of the Electronics Industries Alliance (<http://www.eiae.org/>) for the correct method of disposal.

## How to discard a used battery

Some FURUNO products have a battery(ies). To see if your product has a battery, see the chapter on Maintenance. Follow the instructions below if a battery is used. Tape the + and - terminals of battery before disposal to prevent fire, heat generation caused by short circuit.

### In the European Union

The crossed-out trash can symbol indicates that all types of batteries must not be discarded in standard trash, or at a trash site. Take the used batteries to a battery collection site according to your national legislation and the Batteries Directive 2006/66/EU.

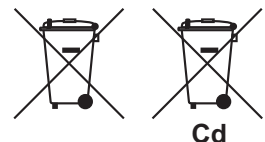

### In the USA

The Mobius loop symbol (three chasing arrows) indicates that Ni-Cd and lead-acid rechargeable batteries must be recycled. Take the used batteries to a battery collection site according to local laws.

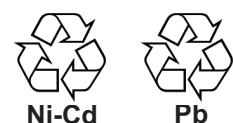

### In the other countries

There are no international standards for the battery recycle symbol. The number of symbols can increase when the other countries make their own recycle symbols in the future.



# SAFETY INSTRUCTIONS

Read these safety instructions before you operate the equipment.



## WARNING

Indicates a condition that can cause death or serious injury if not avoided.



## CAUTION

Indicates a condition that can cause minor or moderate injury if not avoided.



Warning, Caution



Prohibitive Action



Mandatory Action



## WARNING



**Do not open the equipment.**

This equipment uses high voltage that can cause electrical shock. Only qualified persons can work inside the equipment.



**Turn off power at switchboard if the something is dropped inside the equipment.**

Fire or electrical shock can result if the power remains on.



**Turn off power at switchboard if the equipment is emitting smoke or fire.**

Fire or electrical shock can result if the power remains on.



**Turn off power at switchboard immediately if you feel the equipment is not working properly.**

Fire or electrical shock can result if the power remains on.



## CAUTION



**Do not disassemble or modify the equipment.**

Fire, electrical shock or bodily injury can result.



**Do not operate the equipment with wet hands.**

Fire or electrical shock can result.



**Keep the equipment away from rain, water and water splash.**

Fire or electrical shock can result if water gets into the equipment.



**Use the correct fuse.**

Use of a wrong fuse can cause fire.



**Do not place liquid-filled containers on the top of the equipment.**

Fire or electrical shock can result.

**⚠ WARNING**

**⊘ Do not approach the radome closer than 1.4 m (FELCOM 500) or 0.7 m (FELCOM 250) when it is transmitting.**

The radome emits radio waves which can be harmful to the human body, particularly the eyes.

RF power density on antenna aperture	FELCOM500 distance	FELCOM250 distance
100W/m <sup>2</sup>	-	-
25W/m <sup>2</sup>	0.5 m	0.4 m
10W/m <sup>2</sup>	1.4 m	0.7 m

**⚠ CAUTION**

**⊘ The glass of an LCD panel breaks easily. Handle the LCD carefully.**

Injury can result if the glass breaks.

### Warning Labels

Warning labels are attached to the equipment. Do not remove the labels. If a label is lost or damaged, contact a FURUNO dealer about replacement.

**⚠ WARNING ⚠**

To avoid electrical shock, do not remove cover. No user-serviceable parts inside.

**⚠ 警告 ⚠**

感電の恐れあり。  
サービスマン以外の方はカバーを開けないで下さい。内部には高電圧部分が多い数多くあり、万一さわると危険です。

Name: Warning Label (1)  
Type: 86-003-1011-3  
Code No.: 100-236-233-10

**⚠ WARNING警告 ⚠**

To avoid electrical shock, do not remove cover.

感電の恐れあり。サービスマン以外の方はカバーを開けないで下さい。

Name: Warning Label  
Type: 6-021-3517-0  
Code No.: 100-350-230-10

# 505 Emergency Call

---

In the event of an emergency, do the following to make an emergency call:

**Note:** 505 Emergency calling is an INMARSAT service and is not GMDSS compliant.

1. Remove the handset from the cradle, and dial [505] at the idle screen.
2. Press  or [#] to call the number.  
Corresponding to the satellite in use, you will be connected to one of the following RCC services.

Satellite	RCC
EMEA (West Asia, Africa, Eastern Atlantic area)	RCC Den Helder (Holland)
APAC (Western Pacific, Southeast Asia, Oceania area)	RCC Australia (Canberra, Australia)
AMER (Western Atlantic, Eastern Pacific, Continental America area)	JRCC Norfolk (Norfolk, Virginia, USA)

For example, if using the above operation is performed in Japan, it is covered by the APAC service area, and you will be connected to RCC Australia.

3. Once connected to RCC, speak slowly and clearly provide the following information:
  - **Who you are:** Vessel name, telephone number and callsign.
  - **Where you are:** Your position in latitude and longitude or a bearing and distance from a known geographical point.
  - **What is wrong:** Nature of emergency or difficulty.
  - **Type** of assistance required.
  - **Number** of persons on board.

# TABLE OF CONTENTS

---

<b>FOREWORD</b> .....	<b>viii</b>
<b>SYSTEM CONFIGURATION</b> .....	<b>x</b>
<b>1. BASIC OPERATION</b> .....	<b>1-1</b>
1.1 Communication Unit and Handset overview.....	1-1
1.1.1 Communication unit.....	1-1
1.1.2 Handset.....	1-1
1.2 SIM Card.....	1-3
1.3 Power On/Off.....	1-4
1.4 Screen Layout.....	1-6
1.5 Basic Operation of the Handset.....	1-7
1.5.1 Main menu.....	1-7
1.5.2 How to input characters.....	1-9
1.5.3 How to edit text.....	1-10
1.6 Data connection using Web software.....	1-12
1.7 Password.....	1-13
<b>2. HANDSET OPERATIONS</b> .....	<b>2-1</b>
2.1 Handset.....	2-1
2.1.1 How to make a call.....	2-1
2.1.2 Operation during communication.....	2-5
2.1.3 How to receive a call.....	2-6
2.1.4 Call forwarding.....	2-7
2.2 Contacts List.....	2-8
2.2.1 How to add a new contact.....	2-8
2.2.2 How to save a telephone number from History to Contacts.....	2-9
2.2.3 How to search the Contacts list.....	2-10
2.2.4 How to edit a contact.....	2-11
2.2.5 How to delete a contact.....	2-11
2.3 SMS.....	2-13
2.3.1 How to log in.....	2-13
2.3.2 How to send an SMS message.....	2-14
2.3.3 How to view a received message.....	2-15
2.3.4 Message boxes.....	2-16
2.3.5 How to use Received messages.....	2-20
2.3.6 How to use Sent messages.....	2-22
2.3.7 How to use Draft messages.....	2-23
2.3.8 How to use URL and phone numbers within messages.....	2-24
2.4 Web.....	2-26
2.4.1 How to connect/disconnect to/from the Internet.....	2-26
2.4.2 How to view a web page.....	2-27
2.4.3 Operations while viewing a web page.....	2-31
2.4.4 Favorite list.....	2-32
<b>3. SETTINGS FOR HANDSET</b> .....	<b>3-1</b>
3.1 Sound Menu.....	3-1
3.1.1 Notification sound setting.....	3-1
3.1.2 How to adjust keypad tones volume.....	3-2
3.1.3 How to adjust the volume for the microphone.....	3-2
3.2 Display Settings.....	3-3
3.2.1 How to change the font size.....	3-3
3.2.2 How to change LCD brightness and backlight ON time.....	3-4

## TABLE OF CONTENTS

3.2.3	How to adjust the keypad backlight.....	3-5
3.3	SMS Settings .....	3-6
3.3.1	How to set an SMS Signature .....	3-6
3.3.2	How to activate the SMS password .....	3-7
3.4	Web Settings.....	3-7
3.4.1	How to change web browser font size .....	3-7
3.4.2	How to change web page display zoom.....	3-8
3.4.3	How to change web display mode .....	3-8
3.4.4	Advanced settings.....	3-9
3.4.5	How to set time out .....	3-10
3.4.6	How to clear the cache.....	3-10
3.5	Individual Settings Menu .....	3-11
3.5.1	Basic settings .....	3-11
3.5.2	Network settings.....	3-15
3.5.3	SIP settings .....	3-17
3.5.4	How to change operation password for the handset.....	3-18
3.6	System Messages .....	3-19
3.7	Device List.....	3-19
3.8	How to Show TCP/IP, SIP and Software Version information .....	3-20
<b>4.</b>	<b>OPTIONAL DEVICES .....</b>	<b>4-1</b>
4.1	Fax (FAX-2840).....	4-1
4.2	Incoming Indicator (FB-3000).....	4-1
4.3	Incoming bell (FB-3001).....	4-2
<b>5.</b>	<b>WEB SOFTWARE.....</b>	<b>5-1</b>
5.1	How to Open/Close the Web Software .....	5-1
5.2	Screen Explanation .....	5-2
5.3	Status Monitor .....	5-4
5.4	Data Connection .....	5-6
5.5	Contacts .....	5-9
5.5.1	How to register contacts to the Contacts list.....	5-9
5.5.2	How to arrange the Contacts list.....	5-10
5.5.3	How to edit contacts.....	5-11
5.5.4	How to delete data from contacts.....	5-11
5.5.5	How to copy and move contacts data .....	5-12
5.6	SMS (Short Message Service).....	5-13
5.6.1	How to enter the SMS password.....	5-13
5.6.2	How to send an SMS message.....	5-14
5.6.3	How to review a received message .....	5-15
5.6.4	Message boxes .....	5-16
5.6.5	How to use the Sent box.....	5-18
5.6.6	How to use the Draft box.....	5-19
5.6.7	How to set the signature and password .....	5-20
5.7	SIM Card Settings .....	5-21
5.8	Manual Satellite Search .....	5-22
5.9	Log Displays.....	5-23
5.9.1	How to login to a log with password.....	5-23
5.9.2	How to view the Registration log.....	5-24
5.9.3	How to view the Voice call log.....	5-25
5.9.4	How to view the Data connection log.....	5-27
5.9.5	How to view the Event log.....	5-29
5.9.6	How to Download all logs.....	5-30
<b>6.</b>	<b>WEB FUNCTIONS .....</b>	<b>6-1</b>
6.1	Communication Unit Settings.....	6-1



6.1.1	Administrator login.....	6-1
6.1.2	How to display the Information screen .....	6-2
6.1.3	Extension number settings .....	6-2
6.1.4	Group settings .....	6-5
6.1.5	Access code settings.....	6-6
6.1.6	PBX settings.....	6-8
6.1.7	How to set internal call routing .....	6-9
6.1.8	LAN settings .....	6-10
6.1.9	WAN settings.....	6-14
6.1.10	PPPoE settings .....	6-24
6.1.11	How to set the Bridge mode .....	6-41
6.1.12	How to set the Remote access.....	6-43
6.1.13	How to change the password .....	6-44
6.1.14	How to forward the log to a PC .....	6-45
6.2	Device List.....	6-46
6.2.1	How to detect devices automatically .....	6-46
6.2.2	How to change the link setting in the Device list .....	6-47
6.3	How to Save, Load Settings .....	6-49
6.3.1	How to save settings .....	6-49
6.3.2	How to load settings .....	6-49
<b>7.</b>	<b>MAINTENANCE AND TROUBLESHOOTING7-1</b>	
7.1	Periodical Maintenance .....	7-1
7.2	How to Change the Fuse.....	7-2
7.3	Communication Unit (CU) LED Lamps.....	7-3
7.4	Troubleshooting.....	7-4
7.5	Self Test .....	7-6
7.5.1	Handset self test.....	7-6
7.5.2	Communication unit and antenna unit self test .....	7-7
7.6	Error/Warning Messages.....	7-8
7.7	How to Restore Default Settings (Initialize).....	7-9
7.8	System Information.....	7-10
	<b>APPENDIX 1 MENU TREE .....</b>	<b>AP-1</b>
	<b>APPENDIX 2 LIST OF TERMS AND ABBREVIATIONS .....</b>	<b>AP-4</b>
	<b>APPENDIX 3 PARTS LIST, ARRANGEMENT .....</b>	<b>AP-7</b>
	<b>SPECIFICATIONS .....</b>	<b>SP-1</b>
	<b>INDEX .....</b>	<b>IN-1</b>

# FOREWORD

---

## A Word to the Owner of the FURUNO FELCOM 250/500

Congratulations on your choice of the FURUNO FELCOM 250/500 Inmarsat Fleetbroadband Ship Earth Station. We are confident you will see why the FURUNO name has become synonymous with quality and reliability.

Since 1948, FURUNO Electric Company has enjoyed an enviable reputation for quality marine electronics equipment. This dedication to excellence is furthered by our extensive global network of agents and dealers.

This equipment is designed and constructed to meet the rigorous demands of the marine environment. However, no machine can perform its intended function unless operated and maintained properly. Please carefully read and follow the recommended procedures for operation and maintenance.

We would appreciate hearing from you, the end-user, about whether we are achieving our purposes. Thank you for considering and purchasing FURUNO equipment.

## Features

The FELCOM 250/500 consists of an antenna unit, communication unit, and a handset. The FELCOM 250/500 provides telephone, facsimile and data services.

The main features of the FELCOM 250/500 are:

- Conforms to the following standards: INMARSAT Fleetbroadband SDM, IEC 60945 (Ed. 4), IEC 60529 (Ed. 2), IEC 61162-1 (Ed. 2)
- SIM card based billing
- Voice communication: 4 kbps AMBE+2 or 3.1kHz Audio
- Facsimile: 3.1 kHz Audio
- 64kbps ISDN (UDI/RDI) transmission (FELCOM 500 only)
- Packet Communication

Packet	FELCOM 250	FELCOM 500
Standard IP (best effort)	Max. 284 kbps	Max. 432 kbps
Streaming IP	8 kbps, 16 kbps, 32 kbps, 64 kbps, 128 kbps	8 kbps, 16 kbps, 32 kbps, 64 kbps, 128 kbps, 256 kbps

- Simultaneous voice and data transmission
- SMS (Short Message Service) maximum 160 characters.
- Data packet billing-based internet connection

**Note:** ISDN UDI/RDI data streaming and IP packet communication can incur high costs depending on communication time. Note that unexpectedly high costs could occur.

**Software Information**

This product includes software to be licensed under the GNU General Public License (GPL), GNU Lesser General Public License (LGPL), BSD, Apache, MIT and others. The program(s) is/are free software(s), and you can copy it and/or redistribute it and/or modify it under the terms of the GPL or LGPL as published by the Free Software Foundation. Please access the following URL if you need source codes: [https://www.furuno.co.jp/contact/cnt\\_oss.html](https://www.furuno.co.jp/contact/cnt_oss.html)

This product uses the software module that was developed by the Independent JPEG Group. France Telecom - TDF - Groupe des Ecoles des Telecommunications Turbo codes patents license.

**Program No.**

- 1650233-09.\*\*

\*\* denotes minor modifications.

# SYSTEM CONFIGURATION

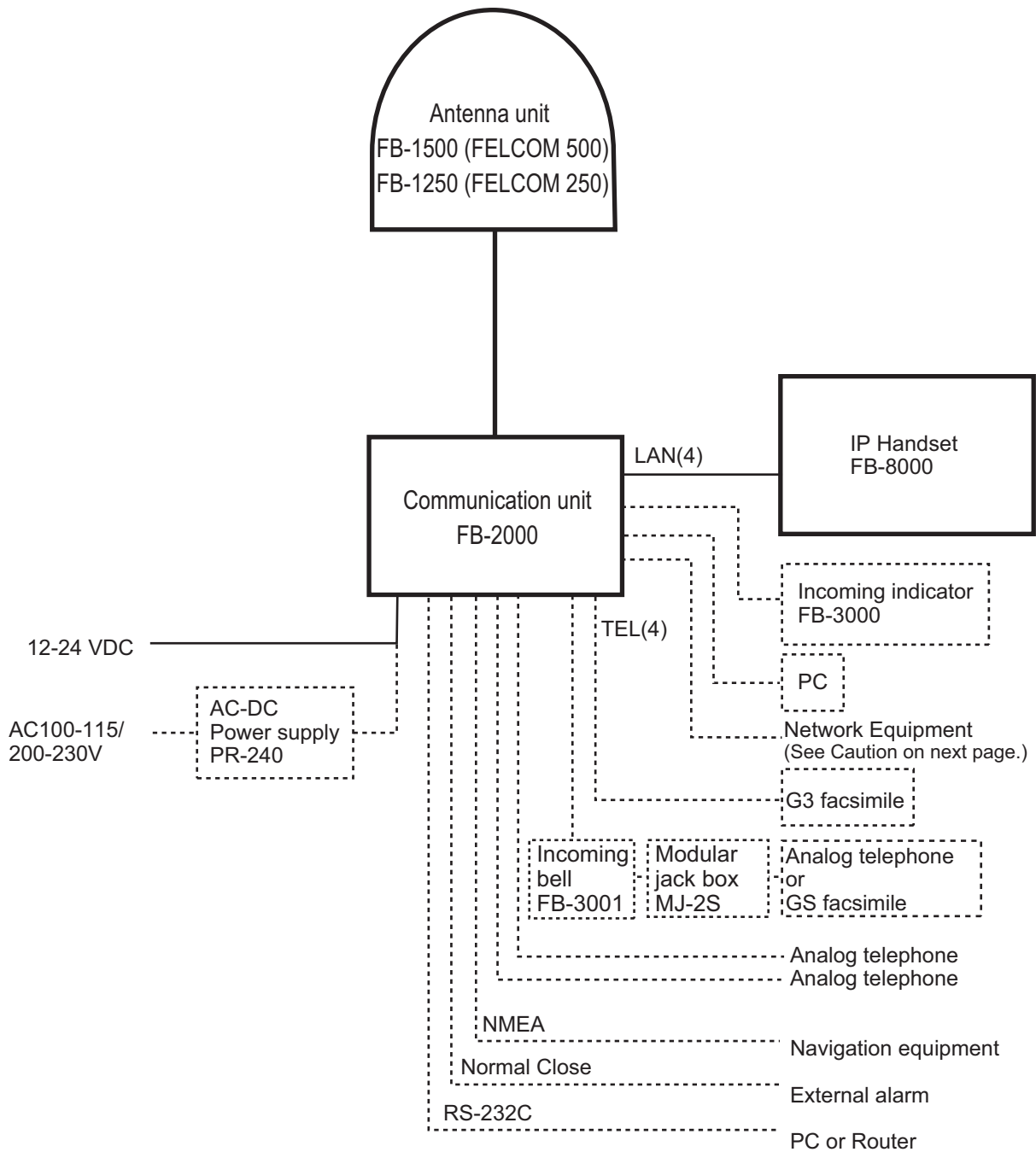

## Environmental Category

Antenna unit	To be installed in an exposed area
Communication unit, IP handset, Incoming indicator, Incoming bell	To be installed in a protected area

**Caution when connecting shipboard network to FELCOM 250/500**

If the FELCOM 250/500 is connected to a shipboard network that has a data monitoring system or the like, the FELCOM 250/500 can become unstable when the equipment in the network transmits large volumes of broadcast packets. If this type of shipboard network is connected to the FELCOM 250/500, consultation with the network system manager is necessary to provide measures to ensure the FELCOM 250/500 operates stably.

An example of a system that transmits and receives large volumes of broadcast data is a data monitoring system which has equipment that transfers large data (images, etc.) in short intervals. One remedy is to connect a router (that is capable of handling large volumes of data) between the shipboard network and the FELCOM 250/500.

This page is intentionally left blank.

# 1. BASIC OPERATION

## 1.1 Communication Unit and Handset overview

### 1.1.1 Communication unit

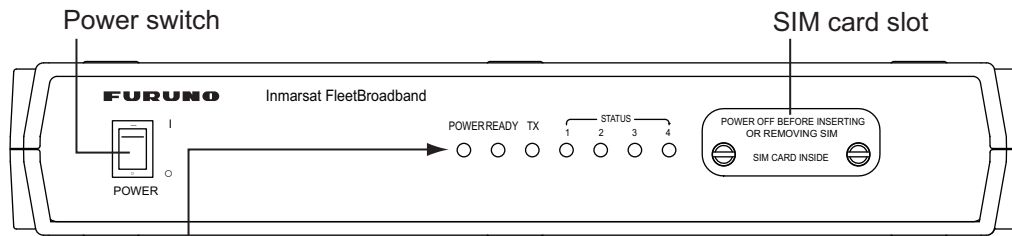





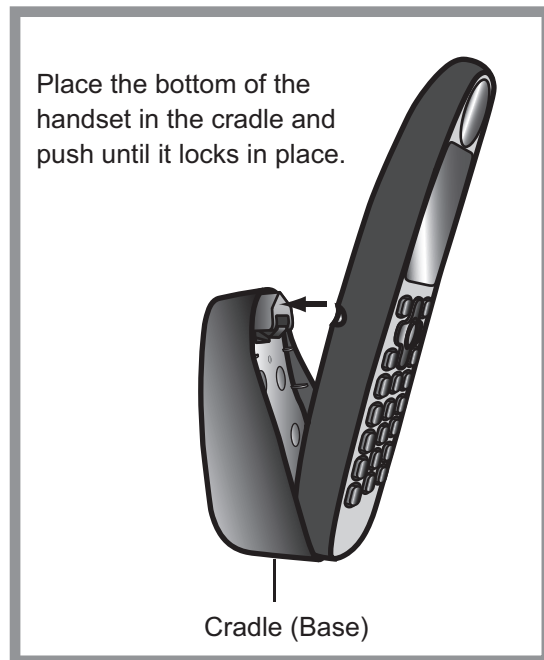
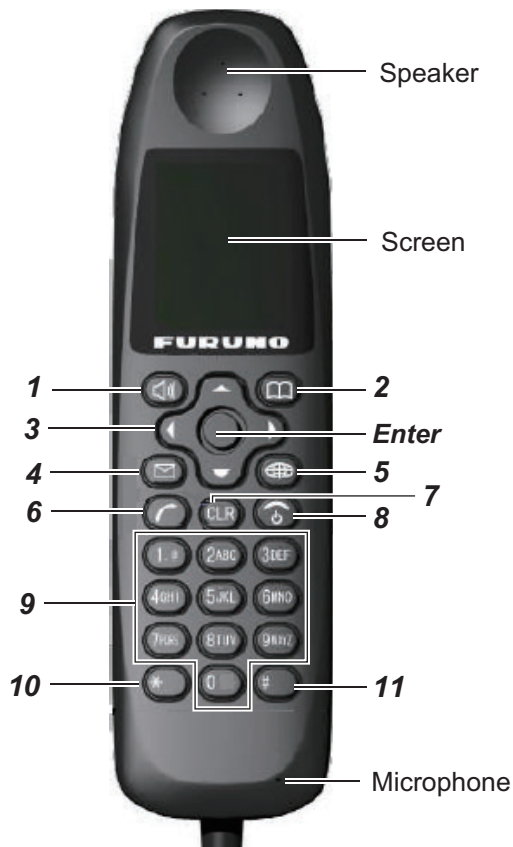

#### Status lamps

- POWER:** Lights green when power is on.
- READY:** Lights green when a satellite is being tracked.  
(Voice/Data communication available)
- TX:** Lights green when transmitting.
- STATUS (1 - 4):** Lights green when operating correctly.

### 1.1.2 Handset



1. BASIC OPERATION

Number	Key	Function
1		<ul style="list-style-type: none"> <li>• Opens the [Sound] menu.</li> <li>• Softkey (Lower left menu item button)</li> </ul>
2		<ul style="list-style-type: none"> <li>• Opens the Contacts screen.</li> <li>• Softkey (Lower right menu item button)</li> </ul>
3	▲	<ul style="list-style-type: none"> <li>• Moves the cursor up.</li> <li>• Increases the volume.</li> </ul>
	▼	<ul style="list-style-type: none"> <li>• Moves the cursor down.</li> <li>• Decreases the volume.</li> </ul>
	◀	<ul style="list-style-type: none"> <li>• Moves the cursor left.</li> <li>• Opens Incoming History.</li> </ul>
	▶	<ul style="list-style-type: none"> <li>• Moves the cursor right</li> <li>• Opens Outgoing History.</li> </ul>
	ENTER 	<ul style="list-style-type: none"> <li>• When Information window is not displayed: Opens the Main Menu.</li> <li>• When information window is displayed: Displays new information.</li> <li>• Softkey: Execute content that appears at center bottom of screen.</li> </ul>
4		Opens [SMS] menu.
5		Opens [Web top] menu.
6		<ul style="list-style-type: none"> <li>• Call</li> <li>• Answers phone.</li> </ul>
7	CLR	<ul style="list-style-type: none"> <li>• Returns to the previous menu.</li> <li>• Erases a number or letter.</li> </ul>
8		<ul style="list-style-type: none"> <li>• Hangs up phone.</li> <li>• Cancels operation.</li> <li>• Long push: Restart handset.</li> </ul>
9	1. @	<ul style="list-style-type: none"> <li>• Selects item corresponding to number.</li> <li>• Enters phone number and text.</li> </ul>
	2ABC	
	3DEF	
	4GHI	
	5JKL	
	6MNO	
	7PORS	
	8TUV	
	9WXYZ	
	0	Enters phone number and text.
10	*	<ul style="list-style-type: none"> <li>• Press once for (*) and twice for (+) at the transmit screen.</li> <li>• Enters text.</li> </ul>
11	#	<ul style="list-style-type: none"> <li>• Symbol (#)</li> <li>• Enters text.</li> </ul>



## 1.2 SIM Card

**Note:** The FELCOM 250/500 uses only Inmarsat Fleetbroadband compatible SIM cards.

Individual user information is stored on the SIM card. The system reads information when the SIM card is inserted. The user registration number is saved on the SIM card, and it is possible to transmit with different SIM cards from one terminal. In this case, the transmission fees are charged to the person registered to the SIM Card. Contact addresses can be saved on the SIM card.

There are 4 registration codes on the SIM card, [PIN1], [PUK1], [PIN2], [PUK2]. This unit does not use the code [PIN2] and [PUK2]. Be sure to carefully write down the [PIN1] and [PUK1] code numbers and do not lose or forget them.

### PIN code

To prevent unauthorized use by a third party, there is a 4-8 digit PIN (Personal Identification Number) code. When the unit is turned on, the user will be prompted to enter the PIN code. Enter the [PIN1] code. If the wrong code is entered 3 times, the system will lock and the Communication Unit cannot be used.

### PUK code

If the system locks, use the 8-digit PUK (PIN Unblocked Key) code to unlock the system. Use the code [PUK1]. If the wrong PUK code is entered 10 times, the SIM card will cease operating. If this happens, contact the retailer of the SIM card.

### Handling the SIM card

- Ensure the power is off before inserting/removing the SIM card.
- Do not touch the IC part of the SIM card.

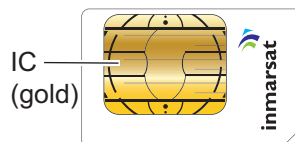

- Always remove the SIM card by hand.

## 1.3 Power On/Off

### How to turn on

The **POWER** switch on the front panel of the Communication Unit switches all units of the FELCOM 250/500 terminal on/off:

- IP Handset
  - Communication Unit
  - Antenna Unit
  - Incoming Indicator (option)
1. By hand, loosen the two screws near the insertion slot on the front of the Communication Unit and remove the cover plate. The SIM card port is found underneath.
  2. Insert the SIM card IC face down into the card port.

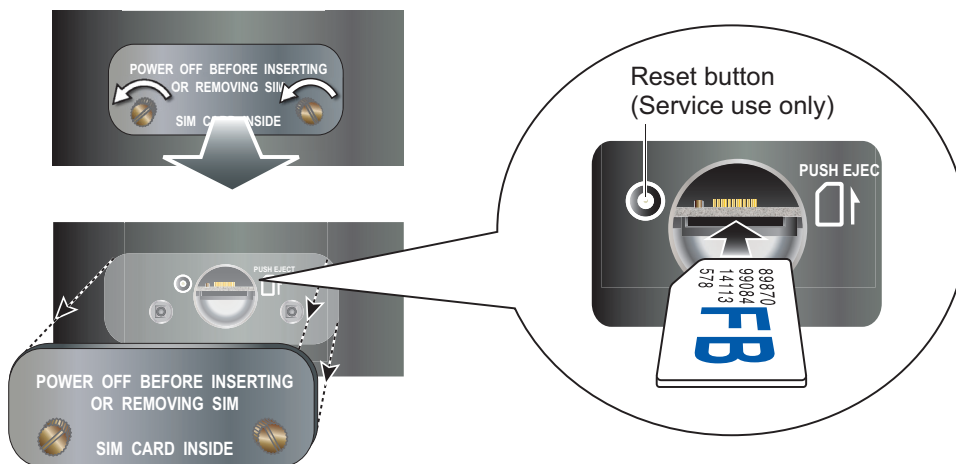

To eject the SIM card, push it in with your finger.

3. Replace the cover unfastened at step 1.
4. Turn on the power switch on the Communication Unit. When the following screen displays "V: Ready / 0" and "D: Not connected\*" on the handset, communication is possible. Wait approx. three minutes for this screen to display.

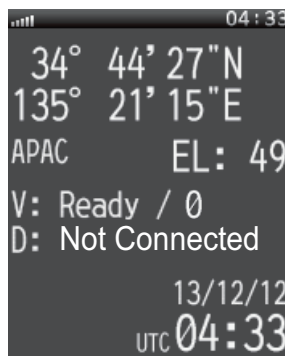



\* If the handset's IP address is not set by web software, "D: No Permission" is shown.

Idle screen

**Note 1:** Usually, about 3 minutes is required for the above screen to display. If there are obstacles or interference in the path of the satellite, more time may be required.

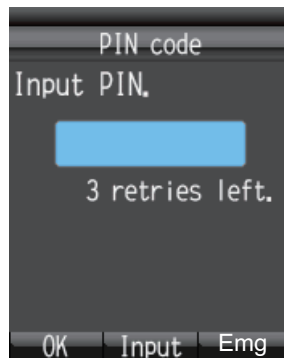
**Note 2:** You may be asked for PIN code depending on SIM card settings. If password is required, go to step 5.





5. Press the **Enter** key to display the PIN code input screen.
6. Enter the 4- to 8-digit SIM PIN code, and press the **Enter** key.
7. Press the  key.  
If the PIN code is entered correctly, the idle screen appears on the handset. If entered wrong, the message "PIN code is invalid" appears.
8. To brighten the screen, press the ▲ key while pressing the [0] key. To darken the screen, press the ▼ key while pressing the [0] key. The brilliance of the screen can be adjusted from any screen.

**Note:** You can call the 505 emergency number with no PIN code.

#### **If the PIN code is locked**

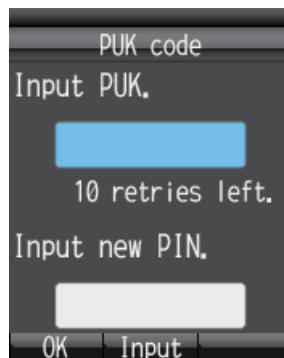
If the wrong PIN code is entered three times consecutively, the current PIN number becomes locked and the PUK screen looks like the one shown below. Do the procedure below to unlock the PIN code.



1. Press the **Enter** key to display the PUK code input screen.
2. Enter the SIM card PUK code. Press the **Enter** key.
3. Press ▼ to select the [Input new PIN.] field then press the **Enter** key.
4. Enter the new PIN code then press the **Enter** key.
5. Press the  key.

## 1. BASIC OPERATION

### Handset and web software operational ability

The following operations are possible using the handset and Web software:

Item	Handset	Web Software
Phone	Yes	No
Contacts	Yes	Yes
SMS (Short Message Service)	Yes	Yes
Internet	Yes	Yes
Handset settings	Yes	Yes (possible with SIP client setting, network setting only)
Communication Unit settings	No	Yes

## 1.4 Screen Layout

### Handset Screen

The diagram shows a handset screen with the following elements and labels:

- Status bar:** Shows signal strength, FX mode, alarm, and time (04:29).
- Ship latitude:** 34° 44' 27" N
- Ship longitude:** 135° 21' 15" E
- Satellite in use:** APAC
- Elevation:** EL: 49
- Voice status \*1:** V: Ready / 0
- Data status \*2:** D: Not Connected
- Time:** 13/12/12 UTC 04:33

An **Alert information window** is shown with the following items:

- Missed call (1)
- New SMS (1)
- New SysMsg (1)

(Above window appears when unread information exists. Number in parentheses is number of items.)

**\*1: V: -- / 0 (Unavailable)**

- V: Ready / 0 (Ready)
- V: Voice / 0 (Voice line busy)
- V: Fax / 0 (Fax transmitting)
- V: UDI / 0 (Using ISDN UDI) (FELCOM 500 only)
- V: RDI / 0 (Using ISDN RDI) (FELCOM 500 only)

**\*2: D: -- (Unavailable)**

- D: Not connected (Data line disconnected)
- D: Connected (Data line connected)
- D: No permission (No connection permission)

### Status indication

Icon	Definition
	Reception strength: Satellite receive signal strength shown by 8 bars.
	FX mode: Shown when FX mode is active. See "Important Notices" at the start of this manual for more details.
	Missed call: Appears when incoming call is missed. (When the missed call indication feature is activated.)
	New Message: Displays when a new SMS message arrives. (When the message arrival notification features is activated.)
	Alarm: Appears when there is a trouble in the same network. Buzzer sounds.
	Shows the current UTC time.

## 1.5 Basic Operation of the Handset

### 1.5.1 Main menu

The handset main menu has 9 items: [Web], [SMS], [SysMsg], [Display], [Contacts], [Sound], [Device], [Setting], and [Info].

1. At the idle screen, press the **Enter** key to open the main menu.

Cursor (Light-blue highlight)

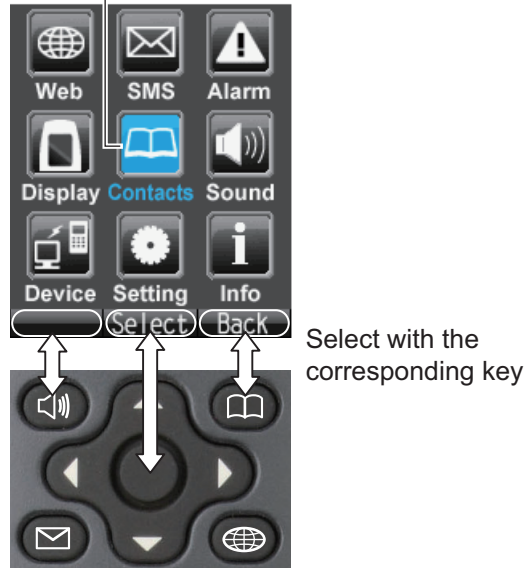

2. Press ◀, ▲, ▶ or ▼ to select an icon in the menu. The selected icon is highlighted in light-blue.
3. Press the **Enter** key to choose [Select]. The corresponding menu displays for the selected item. For example, if you select [Display] at step 2, the following menu appears.

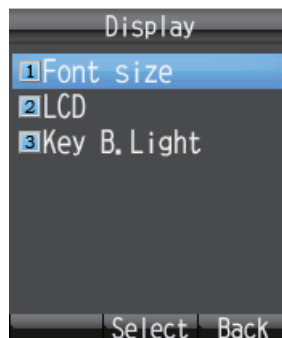

## 1. BASIC OPERATION

- In the selected menu, press ▲ or ▼ to choose a menu item, and press the **Enter** key to open the item. Or press the corresponding number key for that item. The item screen appears. As an example, the [Font size] menu is shown below.

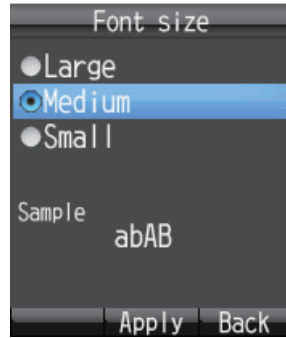

- Press ▲ and ▼ to select an item then press the **Enter** key. A pop-up window like the one below appears for three seconds.

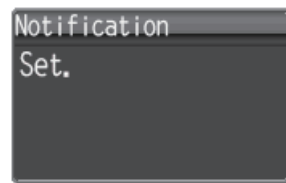

- Press  to close the menu.

## 1.5.2 How to input characters

Input alphabet and numeric characters using the keys on the handset. Press the key once to input a number, or press repeatedly to cycle through alphabet characters.

Key	Alphanumeric character (abAB mode)	Character (1234 mode)
1	., @, -, _, /, :, 1	1
2	a, b, c, A, B, C, 2	2
3	d, e, f, D, E, F, 3	3
4	g, h, i, G, H, I, 4	4
5	j, k, l, J, K, L, 5	5
6	m, n, o, M, N, O, 6	6
7	p, q, r, s, P, Q, R, S, 7	7
8	t, u, v, T, U, V, 8	8
9	w, x, y, z, W, X, Y, Z, 9	9
0	Space, 0, symbols	0
*	~, ?, ,(comma),', !	n/a
#	<ul style="list-style-type: none"> <li>If characters are not fixed, cycle through characters in reverse order.</li> <li>If the cursor is on a character, press to insert a line break.</li> </ul>	.

### Example of text input

For example, to enter "furuno" at the text input screen, do the following:

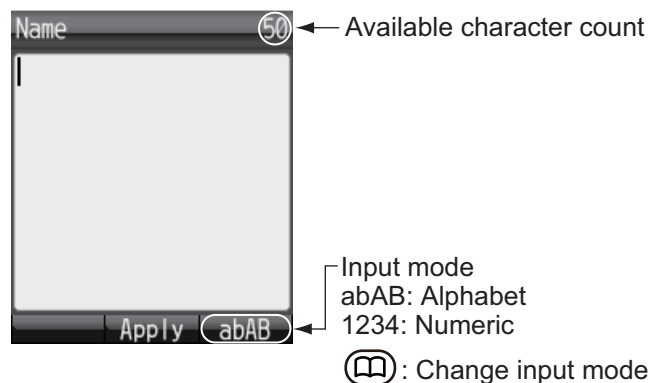

- 1) With [abAB] selected in the lower right of the screen, press the **3** key three times.  
**Note:** Press the **CLR** key to delete a character.
- 2) Press **8** two times.
- 3) Press **7** three times.
- 4) Press **8** two times.
- 5) Press **6** two times.
- 6) Press **▶**.  
To continue input with the same key, move the cursor right one space.
- 7) Press **6** three times.  
**Note:** Press **▼** for a line break at the end of a sentence, or **#** for a line break in the middle of a sentence.

### 1.5.3 How to edit text

Edit text at the text input screen.

#### How to correct text

1. At the text input screen, put the cursor at the beginning of the text to correct.
2. Press the **CLR** key. One character erases.  
**Note:** To erase all characters to the right of the cursor, press and hold the **CLR** key down.
3. Input the correct character(s).

#### How to copy or cut text

Copy (or cut) indicated text and paste into another message.

1. At the input screen, press the  key to open the sub menu.

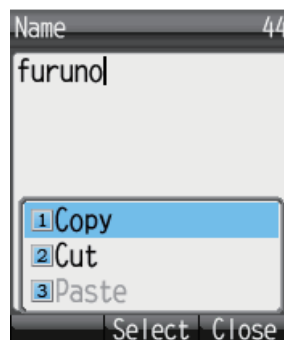

2. Press **1** (to Copy), or **2** (to Cut).
3. Place the cursor at the beginning of the text to copy or cut, and press the **Enter** key.
4. Press **▶** to move the cursor and highlight the desired text to copy or cut (maximum 192 characters).  
**Note:** Press the **CLR** key to reselect the text to copy or cut.

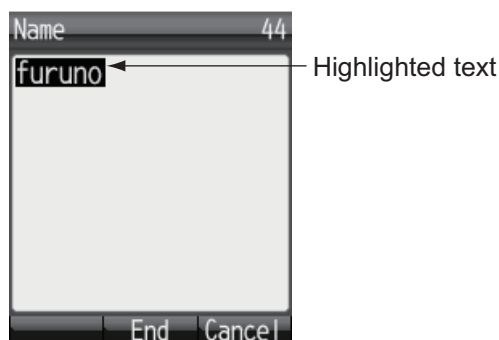

5. Press the **Enter** key. The text is copied to the clipboard (max.10 text items). If you copy an 11th text item, the oldest text item is erased.



**How to paste text**

Paste text from the clipboard into a message.

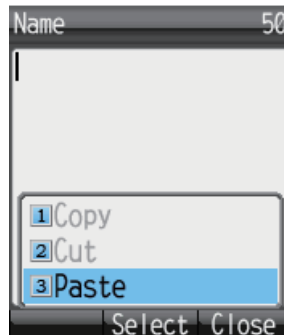

1. Move the cursor to the position to paste the text.
2. Press the  key to open the sub menu.

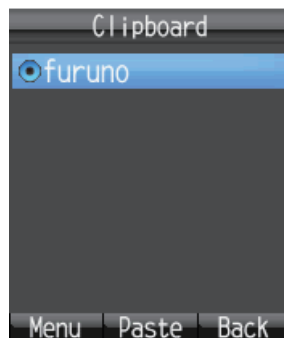

3. Press the **3** key to select [Paste].  
The latest item is at the top of the list.



4. Press **▲** or **▼** to select the item to paste.

**Note:** To view the detailed information screen, with the item selected, press , **1**(Detail) in that order. Press  to return to the clipboard.

5. Press the **Enter** key. Character appears at the location selected at step 1.

**How to delete items from the clipboard**

Delete one or all items from the clipboard as follows.

1. Open the clipboard screen. To delete one item, refer to step 2. To delete all items go to step 3.
2. Press **▲** or **▼** to select the item to delete.
3. Press the  key to open the submenu.

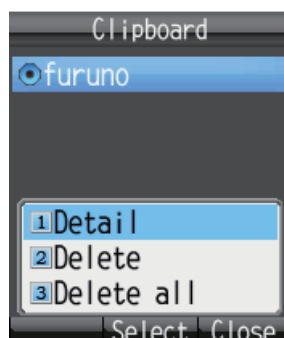

## 1. BASIC OPERATION

- To delete one item, press **2** [Delete]. To delete all items press **3** [Delete all]. One of the following confirmation screen appears:

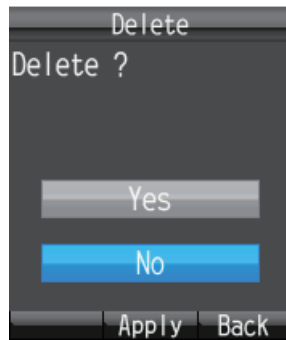

[Delete] selected



[Delete all] selected

- Press **▲** to select [Yes], and press the **Enter** key. When complete, the message "Deleted" or "All deleted" displays.

## 1.6 Data connection using Web software

Below are the procedures to connect to the internet. Refer to chapter 5 for how to activate the Web software and the details of data connection.

### How to connect to the internet

Follow the procedure shown below to connect to the internet.

- Click [Main] in the menu bar.

See "IMPORTANT NOTICES" (page i).

Menu Bar

\*: Below will be shown when the equipment cannot connect to/is disconnected from the internet.

- “---” (cannot be used): When the equipment is not logged into the satellite system.
- “No permission” (internet connection is not permitted): The IP address of PC is not registered to the user list. (Refer to page 6-16 for the details.)

- Click [Data connection] in the sub menu to show the data connection display.

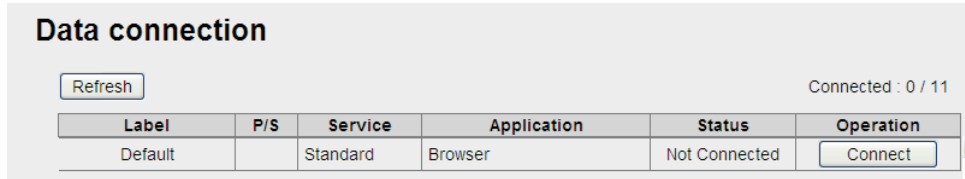

- Click the [Connect] button of the service to use.  
When connecting, the message "Now connecting..." is displayed. When connected, the message "\*\*\*\*connection success." appears.
- Click [OK] to close the message.  
When connected to the internet, the connection list is displayed as shown below.

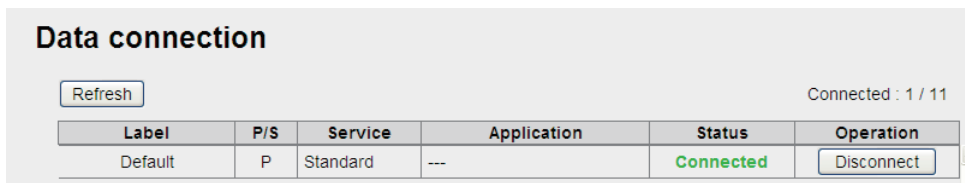

- Open the desired application software and begin data communication.

### How to disconnect from the internet

Do the following to disconnect from the internet:

- Click [Main] in the menu bar.
- Click [Data connection] to show the [Data connection] screen.
- Click [Disconnect] for the services to disconnect. When disconnecting, the message "Now disconnecting..." is displayed. When disconnected, the message "\*\*\*\*disconnection success." is displayed. (\*\*\*: Service and application)
- Click the [OK] button to close the message. The [Status] field displays "Not Connected", the [Operation] button shows "Connect".

## 1.7 Password

Refer to the following table for information on passwords:

	Password	Use	Password Update
Handset	Operation password* <sup>1</sup>	Delete all items and display specific menus.	Refer to paragraph 3.5.4.
	SMS password* <sup>1</sup> , * <sup>2</sup>	When accessing SMS menu.	Refer to paragraph 6.1.13.
	SIP password	Authentication password for SIP server. When you change the SIP password you must also change the extension line password to the same, by WEB software.	Refer to paragraph 3.5.3.

## 1. BASIC OPERATION

	Password	Use	Password Update
Web Software	Log password *1	When opening logs.	Refer to paragraph 5.9.1.
	Administrator password*1	When logging in as administrator.	Refer to paragraph 6.1.13.
	SMS password*1, *2	When opening SMS top menu.	Refer to paragraph 6.1.13.
	extension line password	When registering a new extension line. Password is the same as handset SIP password.	Refer to page 6-2.
	PPPoE password	When connecting to the internet by PPPoE.	See page 6-24.

\*1The factory set password is "01234567".

\*2 SMS password for handset and web software is commonly used.

### How to enter the password

This section explains how to enter the operation password. When prompted for a password, do the following:

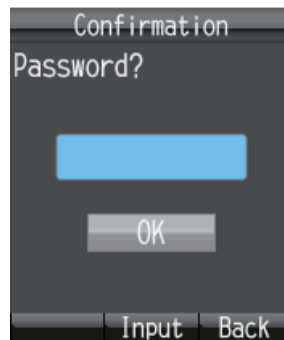

1. Press the **Enter** key to open the password input screen.
2. Enter the password, and press the **Enter** key.

Press the  key to change between input modes:

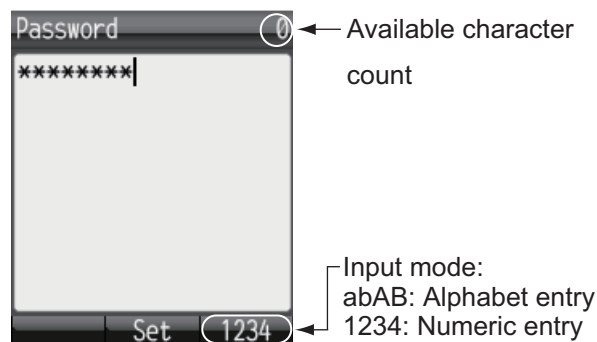

3. Press the ▼ key to select [OK], then press the **Enter** key.

**Note:** If the entered password is wrong, the message "Incorrect" appears. Enter the correct password.

## 2. HANDSET OPERATIONS

---

### 2.1 Handset

You can call someone on land or ship-to-ship from the handset. This unit allows the handset to be used at the same time as the internet.

#### 2.1.1 How to make a call

There are three methods to make a call:

- 1) Enter the number (or short dial number) of the party to call.
- 2) Select a number from the call History.
- 3) Select a number from the Contacts list.

You can call someone on the idle screen indicated "V: Ready / 0".

##### How to enter a number

To enter a number from the handset, do the following:

1. Remove the handset from the cradle, and enter the number from the idle screen:



**Land:** [00], country code, subscriber number.

**Ship-to-ship (Inmarsat terminal):** [00], [870] (ocean area code), Inmarsat Fleet-broadband number.

**Internal call:** 4 digit inter-line number

**Short dial:**[0], short dial number (two digits). Where there is an Access code or Bearer assigned, [Access code/Bearer number], [\*], [0], short dial number.

**Note 1:** To erase a number that is entered wrong, press the **CLR** key.

**Note 2:** There are two voice services, "4kbps AMBE+2" and "3.1kHz Audio". Select the service to use by entering [1][\*] or [2][\*] before the phone number. If nothing is input before the number, "4kbps AMBE+2" is used by default. Depending on SIM card contract, "3.1kHz Audio" cannot be used. Contact the company which issues your SIM card for details.

2. HANDSET OPERATIONS

Service	Charge	Selection Method	Display on idle screen
4kbps AMBE+2 (Standard quality)	Low cost	[1][*] + subscriber number	Voice
3.1kHz Audio (High quality)	High cost	[2][*] + subscriber number	Fax

2. Press the  key or press the **Enter** key to send the call. The indication shown below appears on the screen.

**Note:** If connection fails, the message "Can't connect" appears.

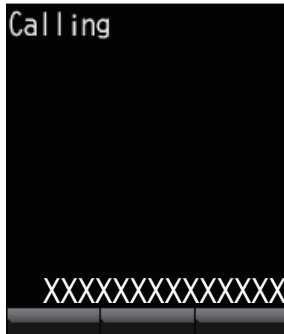

3. Complete the conversation.  
During conversation, the duration of the communication time is counted and displayed on screen (in seconds).

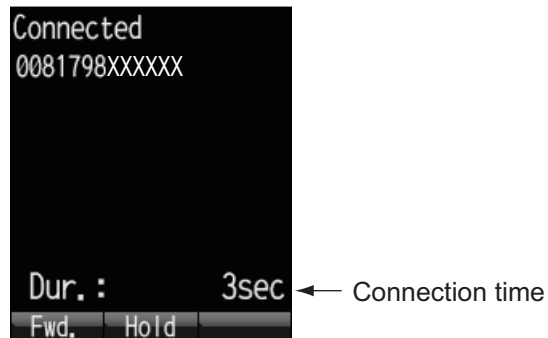

4. Press the  key or replace the handset in the cradle to end the call. The duration of the call is indicated in the display for three seconds and the idle screen appears.

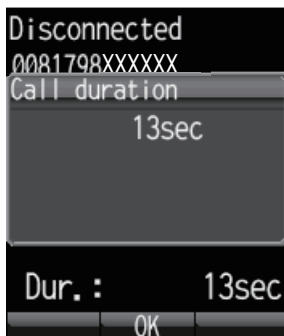

**Note:** To make a telephone call from land to the Inmarsat Terminal FELCOM 250/500, dial the identification code of the telephone carrier, [870] (ocean area code) then the Inmarsat number.

### How to place a call from the History list

A number can be dialed directly from the outgoing and incoming call history list. Up to 20 calls can be stored in each history list. When the 21st call occurs, the oldest logged call is deleted from the list.

- From the idle screen press ◀ (for incoming history) or ▶ (for outgoing history). The caller's name appears in the history list if it is registered in the Contacts list. "No-caller-ID" appears if the number is hidden. Press ◀ and ▶ to change between incoming and outgoing history.

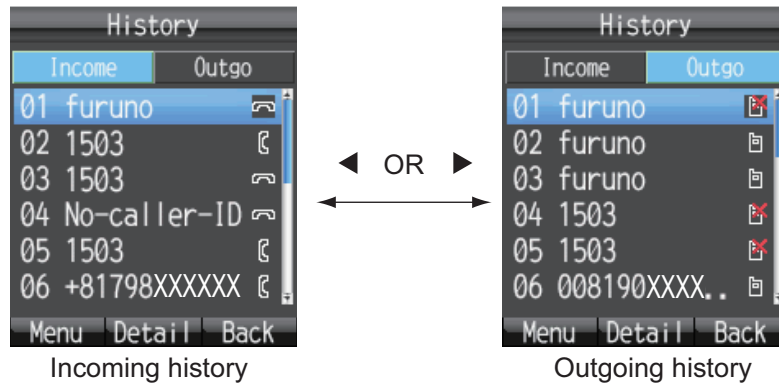

 : Received

 : Missed

 : Communication successful

 : Communication failed

**Note:** When there are no numbers registered in the incoming or outgoing history, "no list" appears.

- Press ▼ or ▲ to select the number to call. **01** is the most recent number.  
**Note:** Press the **Enter** key to view the complete information for the selected number. The incoming/outgoing call time log, etc. appear. Press the  key to return to the History list.

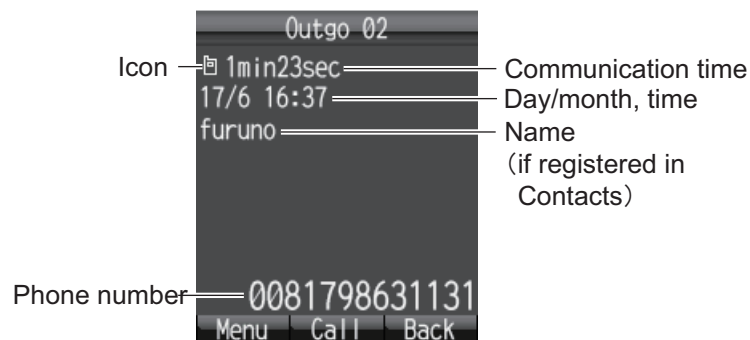

- Press the  key to dial the selected number.

**Operations from the submenu of the History screen**

At the incoming or outgoing history screen, press the  key to open the submenu.

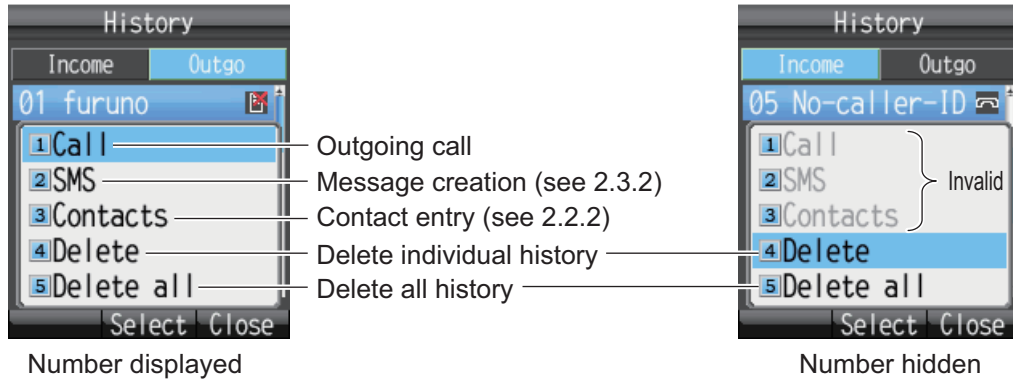

**How to call from the Contacts list**

The Contacts data is saved in the Communication Unit, the handset and the SIM card. For information about creating or saving a new contact, refer to section 2.2.1 or section 2.2.2, for handset, or section 5.5.1 for communication unit and SIM card.

1. At the idle screen, press the  key to open the Contacts screen.

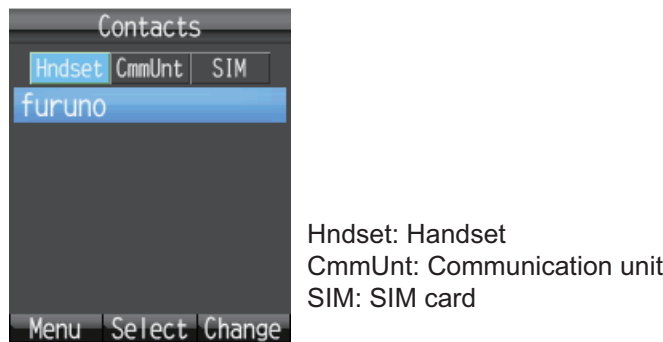

**Note:** If no numbers are stored in the Contacts list, "no list" appears.

2. Press  or  to select the location to view (Handset, CmmUnt, SIM).

**Note:** You can switch between displays with the  key.

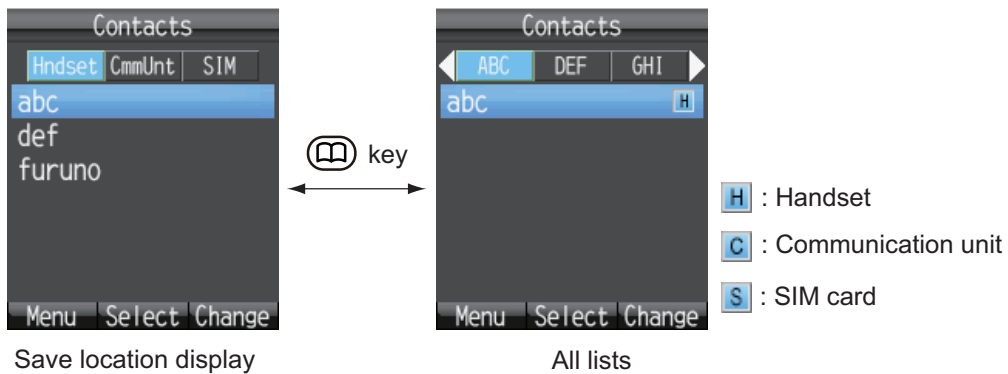

3. Press  or  to select a contact.

**Note:** Press the **Enter** key to display the complete information of the selected contact. Press the  key to return to the Contacts list.



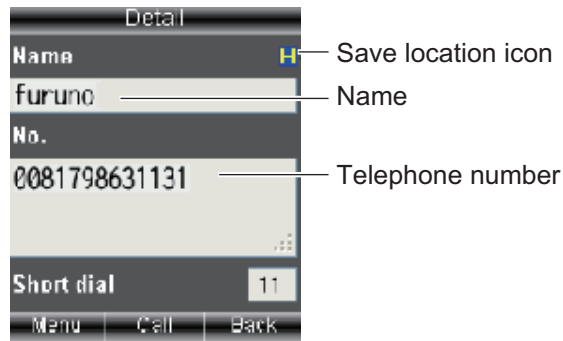

4. Press  to dial the number.

## 2.1.2 Operation during communication

### How to adjust the volume

Adjust the volume of the conversation as follows:

1. During a conversation, press ▲ or ▼ to display the Receive volume screen.



2. Press ▲ to increase the volume, or ▼ to decrease the volume. Press the **Enter** key to set the volume or wait two seconds for the volume to set automatically.

### How to put a call on hold

It is possible to put a call on hold during the conversation.

1. During a conversation, press the **Enter** key.





If the other party puts a call on hold during an internal call, the message "Holding by party" appears.

2. Press the **Enter** key again to take the call off hold and return to the conversation.



### How to answer an incoming call during a conversation

If another call is received during conversation, perform the following:

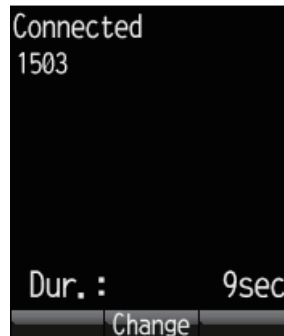
1. To answer the call, press the  key. To disregard the call, press the  key. Then, the incoming caller is rejected and a conversation continues.
2. To switch between callers, press the **Enter** key on the screen where [Change] appears.



**Note:** If another call is received by both you and the other party during conversation, do the following:

- To answer the call, press the  key. To disregard the call, press the  key. Then, the incoming caller is rejected and a conversation continues.

### 2.1.3 How to receive a call

1. When the handset rings, release the handset from the cradle then press the  key.  
If the call is from one of the subscribers described below, the name of the caller is displayed.
  - If the caller is saved in Contacts, the registered name appears.
  - If [Nickname] is set in the [Client set.] menu for a handset, the nickname of the internal telephone appears.
  - The name of the optional phone set in [Notes] of [Settings], [Basic Settings] and [Analog ports] in the Web software name appears.

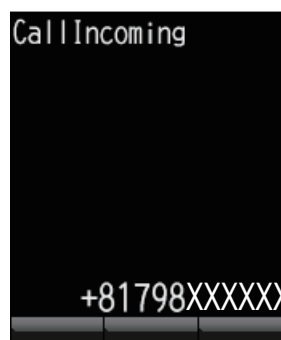

2. Talk to caller.

- When conversation is finished, press the  key to complete the call, or place the handset on the cradle. The communication time appears for 3 seconds and then the idle screen returns.

**Note 1:** If the called party does not answer, a notice appears. Further the missed call icon  appears. (The icon appears if the missed call feature is active.)

**Note 2:** If the quick telephone feature is set for [Act. :OffHook], you can start your conversation as soon as you pick up the handset; it is not necessary to press the  key (see paragraph 3.5.1).

### 2.1.4 Call forwarding

A call can be forwarded to another internal handset.

- During conversation, press the  key.

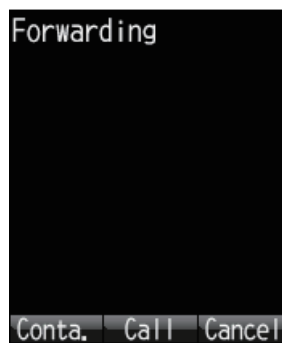

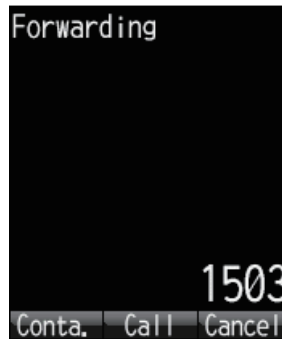

- Enter the 4-digit internal handset number.

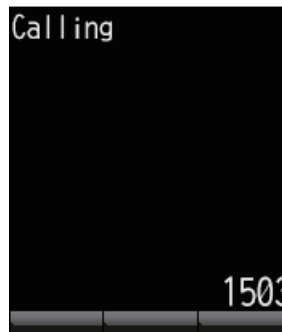

- Press the **Enter** key. The screen changes as follows:





- The following options are available in call forwarding:
  - If the recipient answers: Inform party that you are transferring a call then press the  key. The call is forwarded.
  - If the recipient doesn't answer: press the  key to go to the hold screen. Press the **Enter** key to return to restore normal operation.

## 2.2 Contacts List

Frequently called numbers can be saved in the Contacts list for easy access when phoning or sending an SMS. Save the Contacts list to the handset, the communication unit or the SIM card. The Handset can store 50 contacts. To commonly use a contact with multiple handsets, save it to the contact list in the communication unit or SIM card. See paragraph 5.5.1.

### 2.2.1 How to add a new contact

1. At the idle screen, press the  key to open Contacts.
2. Press the  key to open the submenu.

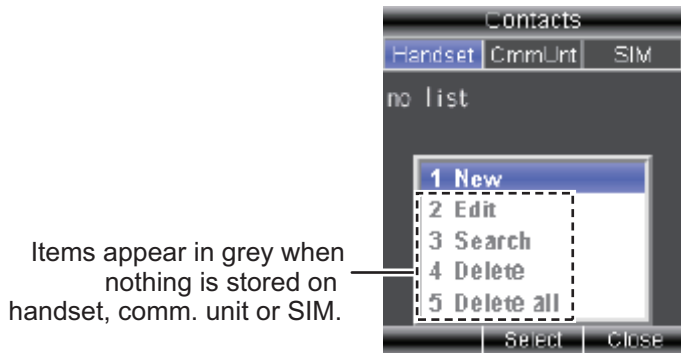

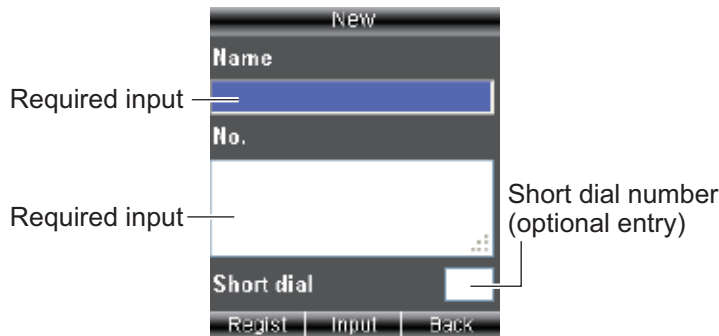

3. With [New] selected, press the **Enter** key, or press **1** to add a new entry.



4. With the [Name] field selected press the **Enter** key.
5. Enter name of party and press the **Enter** key. You can use a maximum of 50 characters. For how to enter data, see paragraph 1.5.2.
6. Press ▼ to select the [No.] field then press the **Enter** key.
7. Enter the telephone number of the party then press the **Enter** key. A maximum of 20 characters can be used. The available characters are numerics, #, \*, and +.



8. Press ▼ to select the [Short dial] field then press the **Enter** key.

9. Assign a short dial number to the contact if required then press the **Enter** key. Short dial numbers must be two digits and can range from [00] to [99]. The handset is able to store 50 short dial numbers.
10. Press the  key. The message "Registered" appears and the contact is saved to the Contacts list in the handset.
11. Press the  key to close the Contacts screen.

**Note:** The contacts screen can be opened with [Contacts] in the main menu.

## 2.2.2 How to save a telephone number from History to Contacts

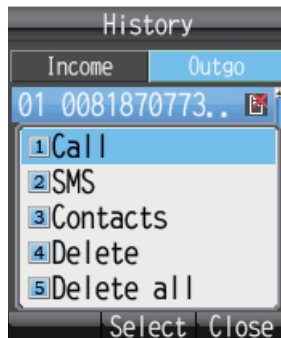

Save a number from the outgoing and incoming History to Contacts.

- 1) At the idle screen, press ◀ to open the incoming history list, or ▶ to open the outgoing history list.
- 2) Press ▲ or ▼ to select the contact to save.
- 3) Press the  key to open the submenu.

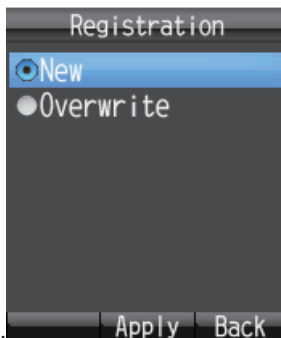

- 4) Press **3** to select [Contacts].





- 5) With [New] selected, press the **Enter** key. The telephone number selected at step 2 appears in the [No.] field.
- 6) With the [Name] field selected, press the **Enter** key.
- 7) Enter a name (max. 50 character), then press the **Enter** key.
- 8) Press the  key. The message "Registered." appears and the number is registered in the Contacts list. The number selected at step 2 now appears as the registered name.
- 9) Press the  key to close the Contacts list.

**Note 1:** To write over a number that already exists in the Contact list, select [Overwrite] instead of [New] at step 5 and press the **Enter** key. Select the contact to overwrite and press the **Enter** key. The new number overwrites the existing number in the [No.] field.

**Note 2:** To register a number entered from the idle screen to the Contacts, press the  key, then **2** to select [Save num.]. The remainder of the procedure is the same as that from step 5 in this procedure.

### 2.2.3 How to search the Contacts list

This section shows you how to search the handset, communication unit and SIM card for registered contact.

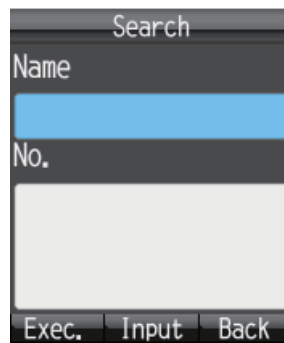

1. Press the  key to open Contacts.
2. Press the  key to open the submenu.
3. Press **3** to select [Search].

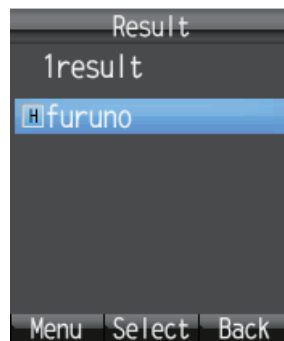

4. Select the [Name] field to search by name, or the [No.] field to search by number. Press the **Enter** key.
5. Enter part of name (or telephone number) then press the **Enter** key.
6. Press the  key to perform the search. The results of the search appear on the Result screen. If the contact can not be found, the message "Not found" displays.





**Note:** To display all the contact data, press the  key at step 5 with nothing entered in the fields.



7. Do one of the following depending on your objective:
  - **Place a telephone call:** Press the  key.
  - **Edit contact:** Press the  key to show the submenu. Press **2** key to select [Edit]. Start from step 5 at paragraph 2.2.4.
  - **Delete contact:** Press the  key to show the submenu. Press **3** key to select [Delete]. Press **▲** to select [Yes] then press the **Enter** key.

## 2.2.4 How to edit a contact

You can edit a contact from the handset in which the contact is registered. Contacts saved to the communication unit and SIM card cannot be edited from a handset (refer to paragraph 5.5.3).

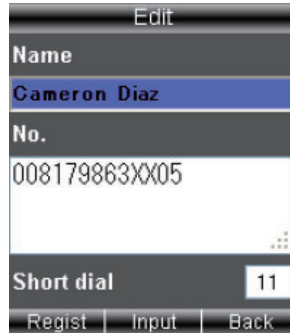
1. At the idle screen, press the  key to open Contacts.
2. With [Handset] selected, press ▲ or ▼ to select the item to edit.
3. Press the  key to open the submenu.
4. Press 2 to select [Edit].







5. Edit the recipient name, number or Short dial number (refer to paragraph 2.2.1).
6. After you edit, press the  key.
7. Press ▼ to select [Overwrite], and press the **Enter** key. The message "Edited" appears.
8. Press the  key to close Contacts.

## 2.2.5 How to delete a contact



You can delete a contact from the handset in which the contact is registered. Contacts saved to the communication unit and SIM card cannot be deleted from a handset. The following two methods are available to delete data (refer to section 5.5.4):

- **Delete individual:** Delete the selected contact.
- **Delete all:** Delete all addresses in the Contacts list.

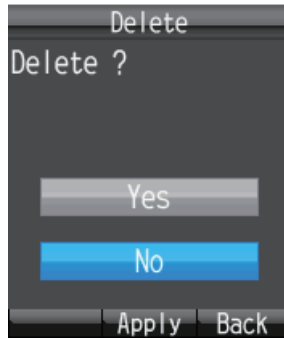

**Delete individual contact**

1. At the idle screen, press the  key to open the Contacts.
2. With [Hndset] selected, press  or  to select the contact to delete.
3. Press the  key to open the submenu.
4. Press **4** to select [Delete].





5. Press  to select [Yes], and press the **Enter** key. The data of the contact selected at step 2 is deleted.
6. Press the  key to close Contacts.

**Delete all**

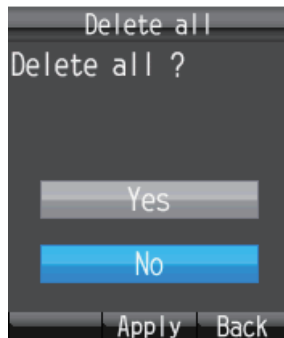
1. At the idle screen, press the  key to open Contacts.
2. Press the  key to open the submenu.
3. Press **5** to select [Delete all]. Operation Password is required.
4. Press the **Enter** key.
5. Enter the operation password, and press the **Enter** key. For information about the operation password, see paragraph 1.7.
6. Press  to select [OK], and press the **Enter** key.



7. Press  to select [Yes], and press the **Enter** key.
8. Press the  key to close Contacts.



## 2.3 SMS

The **Short Message Service (SMS)** allows you to send and receive SMS messages to similarly equipped mobile phones and Inmarsat terminals. An SMS message can have up to 160 alphanumeric characters.

**Note:** Not all mobile phone carriers permit reception and transmission of SMS messages to Inmarsat terminals. Contact your mobile phone carrier for details.

### 2.3.1 How to log in

Log in to access the SMS menu.

1. At the idle screen, press  to open the SMS menu. The following login screen appears.

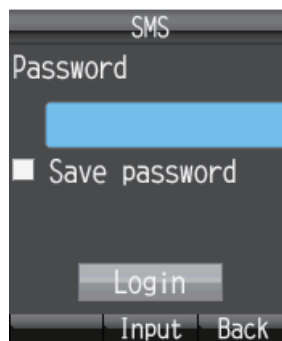

2. Press the **Enter** key.
3. Enter the SMS password and press the **Enter** key. See paragraph 1.7 for information about the SMS password.
4. To shorten the login procedure from the next login, press ▼ to select [Save password], and press the **Enter** key.  
A checkmark [✓] appears in the check-box. See paragraph 3.3.2 for how to set the SMS password for login.
5. Press ▼ to select [Login], and press the **Enter** key.  
If the SMS password is correct, the [SMS] menu appears.  
**Note:** If the password is incorrect, the message "Incorrect password." appears. Enter the password again. In addition to the error message, the idle screen shows "Login failed" and the alarm icon  appears.

**Note:** Descriptions hereafter omit entry of the SMS password.

### 2.3.2 How to send an SMS message

You can send a message with a maximum of 160 characters (alphanumeric, symbols) to a communication terminal that has SMS capability.

1. At the idle screen, press the  key to show the [SMS] menu.

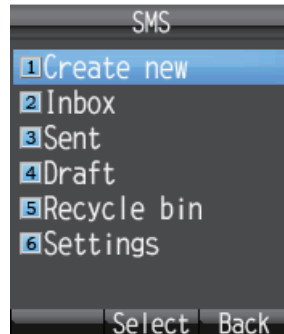

2. Press 1 to select [Create New].

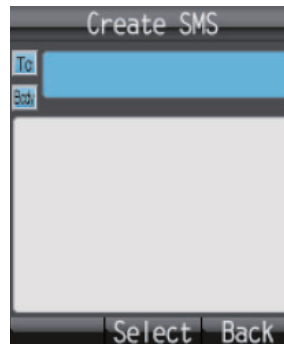

3. With the [To] field selected press the **Enter** key.

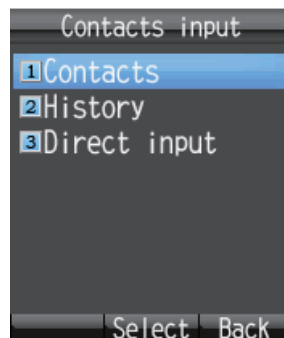



4. Select from the following methods to choose a recipient:  
**To get recipient from Contacts**, press 1, select contact then press the **Enter** key.  
**To get recipient from outgoing History**, press 2, select subscriber then press the **Enter** key.  
**To input recipient number**, press 3, enter number (up to 20 digits) then press the **Enter** key.
5. Press ▼ to select the [Body] field, and press the **Enter** key.
6. Enter the text (maximum 160 characters) in the [Body] field and press **Enter** key.

7. Press the  key to open the submenu.



← Name appears here if telephone number is registered in Contacts.

8. Press **1** to select [Send] to send the message. The message "Sending..." appears while the message is being sent. When completed, the message "Sent." appears.  
**Note 1:** To save a message to the [Draft] box without sending the message, press **2** instead of **1** to select [Save]. The message is saved to the [Draft] box.  
**Note 2:** To cancel sending of a message while the indication "Sending..." is displayed, press .
9. Press  to close the menu.

**Note:** The [SMS] menu can also be accessed with [SMS] on the main menu.

### 2.3.3 How to view a received message

If you receive a message while logged in (with [Save password] set to on), an alarm rings and an alert window appears at the bottom of the screen as shown in the illustration below. Furthermore, the message icon  appears in the status bar at the top of the screen if SMS alert is set to ON (refer to paragraph 3.5.1 for detailed information). When not logged in, neither the alert window nor the icon appears. Manually check if a new message has arrived, when you log in.

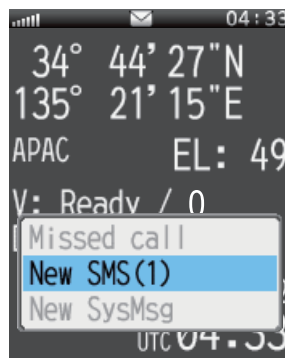

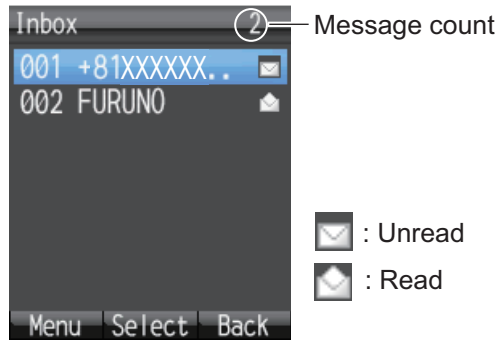

## 2. HANDSET OPERATIONS

1. With [New SMS] selected, press the **Enter** key. The Inbox displays.

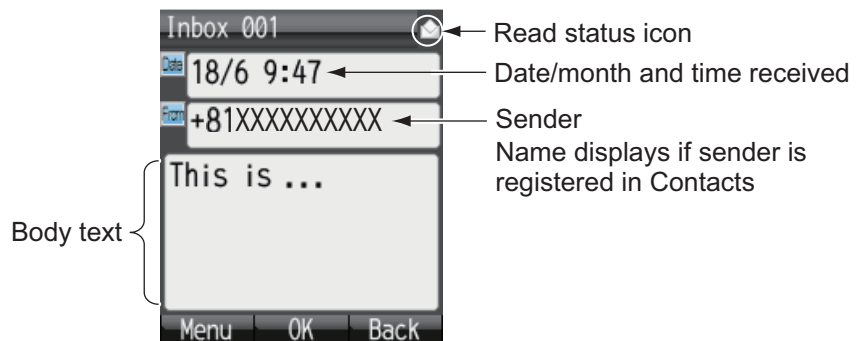

2. Press **▲** or **▼** to select the message, and press the **Enter** key.



**Note:** After displaying the message, press the  key to display the sub menu. The following operations are possible: Reply, Forward, Call, Contacts, Move r. bin (move to Recycle Bin), Copy text. See paragraph 2.3.5.

3. Press the  key to close the message.

### 2.3.4 Message boxes

There are four message boxes: [Received], [Sent], [Draft] and [Recycle Bin]. If there is no message in a box, "No SMS" is displayed. If the amount of messages exceeds the maximum storage capacity, the oldest message is deleted automatically.

Box	Saved Message	Maximum Amount
Inbox	Received messages	200 Messages in total
Sent	Sent messages	
Draft	<ul style="list-style-type: none"> <li>• Un-sent saved messages.</li> <li>• Messages which did not reach intended recipient.</li> </ul>	
Recycle Bin	Messages deleted from [Inbox], [Sent], and [Draft] boxes.	

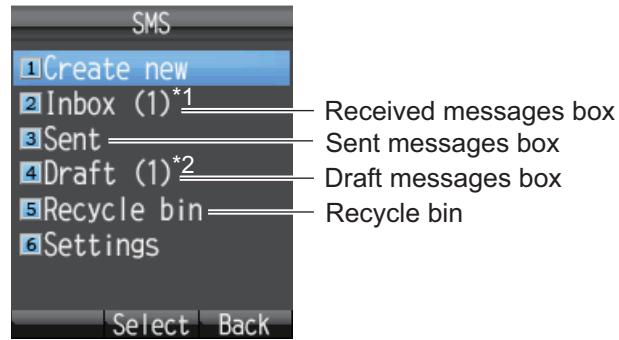

\*1: Unread message count displays in brackets.

\*2: Unsent message count displays in brackets.

### **How to move a message to the recycle bin**

You can move the messages from any box into the Recycle Bin. Messages can be moved individually or all at once.

1. Open the [Inbox], [Sent] box or [Draft]. To move an individual message, go to step 2. To move all messages from the selected box, go to step 3.
2. Press ▲ or ▼ to select the message to send to the Recycle Bin.
3. Press the  key to open the submenu.



4. To move an individual message to the Recycle Bin, press the **1** key to select [Move r. bin]. To move all messages from the selected box to the Recycle Bin, press the **2** key to select [R. bin all]. The message "Moving..." appears during the moving. "Moved" appears when the move is completed.
5. Press the  key to close the box.

**Note:** To move a message to the recycle bin that is opened and being viewed, press the  key and **5** to select [Move r. bin].

### **How to sort messages in a box**

You can sort the messages in the Inbox by date, read/unread status or by sender name. Further, you can arrange messages in the Sent and Draft boxes by either date or recipient name.

1. Open the box ([Inbox], [Sent], or [Draft]) to arrange.
2. Press the  key to open the submenu.

## 2. HANDSET OPERATIONS

3. Press **3** to select [Sort].

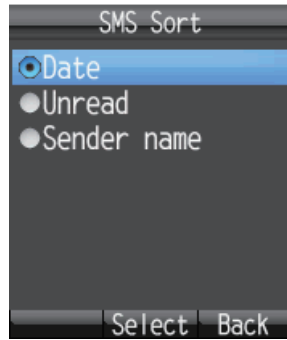

Inbox

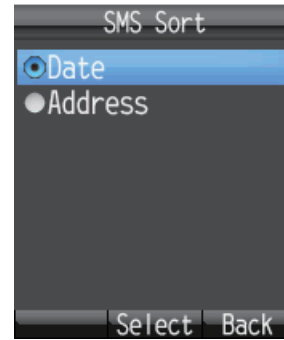

Sent box/Draft box

4. Press **▲** or **▼** to select sort method.  
**Date:** Sort messages by date received, sent, or created.  
**Unread:** Sort messages by unread/read status.  
**Sender name:** Sort messages by sender name (A-Z), number (0-9), and symbol. Senders that are not saved in Contacts display at the top of the list.  
**Address:** Sort messages by address name (A-Z), number (0-9) and symbol. Recipients that are not saved in Contacts display at the top of the list.
5. Press the **Enter** key.
6. Press the  key to close the mailbox.

### **How to move messages from the recycle bin to other boxes**

Messages in the Recycle Bin can be moved to the other boxes. You can move messages individually or all at once.

1. Open the Recycle Bin. For individual message go to step 2; for all messages go to step 3.
2. Press **▲** or **▼** to select the message to send to another box.
3. Press the  key to open the submenu.



- To move an individual message, press **1** to select [Move]. To move all messages, press the **2** key to select [Move all].

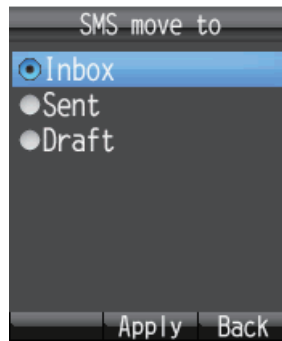

- Press **▲** or **▼** to select the box where to move the message, and press the **Enter** key. The message "Moving..." appears during the move and "Moved." when the move is completed.
- Press the **⏪** key to close menu.

**Note:** You can move a message in the Recycle Bin that is opened and being viewed to another box. Press the **⏪** key, and **1**(Move).

### **How to delete messages in the recycle bin**

The messages in the Recycle Bin can be deleted individually or all at once.

- Open the Recycle Bin. To delete an individual message, go to step 2. To delete all messages, go to step 3.
  - Press **▲** or **▼** to select the message to delete.
  - Press the **⏪** key to open the submenu.
  - To delete an individual message, press **3** (Delete). To delete all messages, press **4** (Delete all). Then, do as follows:
    - If **3**, press **▲** to select [Yes] and press the **Enter** key.
    - If **4**, press the **Enter** key. Enter the operation password and press the **Enter** key. Press **▼** to select [OK] and press the **Enter** key. Press **▲** to select [Yes] and press the **Enter** key. The message "Deleting..." appears during the deleting process and "Deleted" appears upon completion.
  - Press the **⏪** key to close menu.
- Note:** You can delete a message in the Recycle Bin that is opened and being viewed. Press the **⏪** key, followed by **2** (Delete).

### 2.3.5 How to use Received messages



Received messages can be replied to and forwarded. You can also use received messages to telephone the sender of the message, add a sender to Contacts, and copy the text of the message.

#### How to reply to a message

Do the procedure below to reply to a received message.

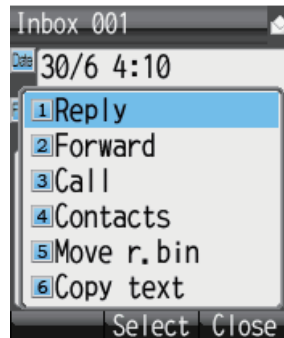

1. Open the Inbox and open the message to reply to.
2. Press the  key to open the sub menu.



3. Press **1** to select [Reply]. The Create SMS screen appears.
4. Press **▼** to select the [Body] field, and press the **Enter** key.
5. Enter the text (maximum 160 characters). Press the **Enter** key when finished.
6. Press the  key to open the submenu.
7. Press **1** to select [Send] to send the message.
8. Press the  key to close the box.

#### How to forward a message



Forward a received message to another recipient as follows:

1. Open the Inbox and open the message to forward.
2. Press the  key to open the sub menu.
3. Press **2** to select [Forward].
4. With the [To] field selected press the **Enter** key.
5. Enter the address of the recipient and press the **Enter** key. (See paragraph 2.3.2.)
6. Press the  key to open the submenu.
7. Press **1** to select [Send] to send the message.
8. Press the  key to close the box.



**How to call the sender of a message**

Call the sender of a received SMS as follows:



1. Open the Inbox and open the message to call sender from.
2. Press the  key to open the submenu.
3. Press **3** to select [Call]. The phone number of the sender appears.
4. Press the  key, or the **Enter** key, to call the number.
5. Press the  key to close the message.

**How to save the sender to Contacts**

Save the address of a sender to Contacts as follows:

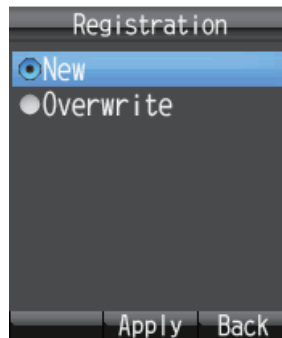

1. Open the Inbox and open the message to save sender.
2. Press the  key to open the sub menu.
3. Press **4** to select [Contacts].



4. With [New] selected, press the **Enter** key. The phone number of the sender appears in the [No.] field.
5. With [Name] selected press the **Enter** key.
6. Enter the name (maximum of 50 characters) of the sender, and press the **Enter** key.
7. Press the  key. The message "Registered" appears and the name is saved to the Contacts list, under the name entered at step 6.
8. Press the  key to close the message.

**How to copy text**

You can copy text in a message as follows:

1. Open the message from which to copy text.
2. Press the  key to open the submenu.
3. Press **6** to select [Copy text].
4. Position the cursor at the beginning of the text to copy and press the **Enter** key.
5. Move the cursor to highlight the text to copy then press the **Enter** key.
6. Press the  key to close the message.

### 2.3.6 How to use Sent messages



Messages in the Sent box can be edited and re-sent. You can also use sent messages to telephone the sender of a message, add a sender to Contacts and copy text of a message.

#### How to edit and send a message

Messages in the Sent box can be edited and sent to the same or different recipient.

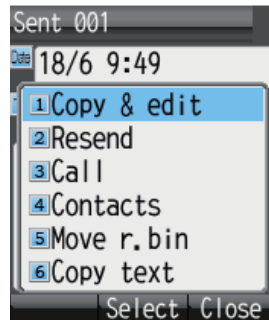

1. Open the Sent box and open the message.
2. Press the  key to open the sub menu.



3. Press **1** to select [Copy & edit]. The [Create SMS] screen appears with the original message text in the [Body] field. To edit and send a message to the original recipient, go to step 6. To send the message to a different recipient go to step 4.
4. To send the message to a different recipient, with [To] selected, press the **Enter** key.
5. Select the recipient. See paragraph 2.3.2.
6. Press **▼** to select the [Body] field, and press the **Enter** key.
7. Edit the body text (maximum 160 characters) and press the **Enter** key.
8. Press the  key to open the submenu.
9. Press **1** to select [Send] to send the message.
10. Press the  key to close the box.

#### How to resend messages

You can resend a message that was already sent.

1. Open the Sent box and open the message.
2. Press the  key to open the submenu.
3. Press **2** to select [Resend] to resend the message.
4. Press the  key to close the box.

### 2.3.7 How to use Draft messages



Un-sent messages, and failed transmission messages are saved in the Draft box. It is possible to edit, resend, copy text, telephone the sender, and save address to Contacts.

#### How to edit and send messages

Edit and send a message in the Draft box as follows:

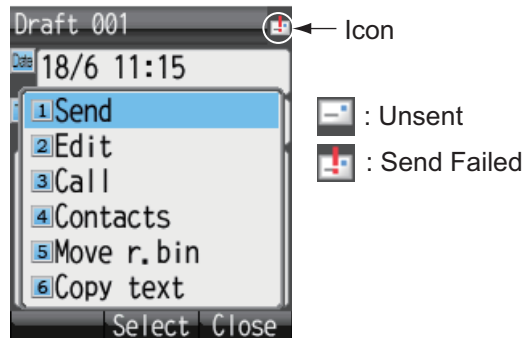
1. Open the Draft box and open the message to edit and/or send.
2. Press the  key to open the sub menu.



3. To edit the message, press **2** to select [Edit]. To send the message without editing, press **1** to select [Send]. If **2** is selected, the [Create SMS] screen appears. Follow directions from step 4. If **1** already has been pressed, follow directions at step 7.
4. Edit the message text.
5. Press the  key to open the submenu.
6. Press **1** to select [Send] to send the message.
7. Press the  key to close the box.

### 2.3.8 How to use URL and phone numbers within messages

If a phone number is included in a message, it can be copied, called, replied to (by SMS), and added to Contacts. If a URL is included in a message, it can be viewed, added to Favorites, and copied.

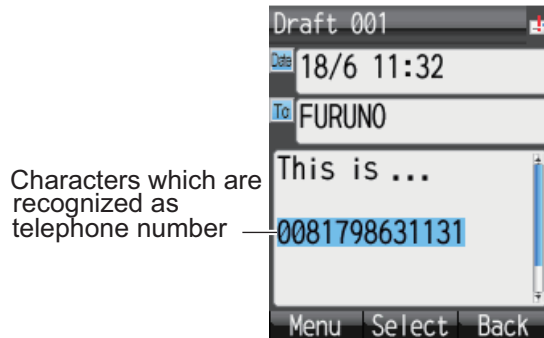

#### Phone numbers

1. Open the message with the included phone number.
2. Press ▼ to select the phone number with the cursor. The phone number is highlighted in light blue. If there are two or more numbers in the message, use ▼ or ▲ to select the one to use.



3. Press the **Enter** key to show the submenu.



4. Do one of the following:
  - **Call the selected number:** Press **1**. Press the **Enter** key or the  key to call.
  - **Send an SMS message to the selected number:** Press **2**. Follow the instructions at step 5 and after in paragraph 2.3.2.
  - **Save the selected number to Contacts:** Press **3**. Follow the instructions at step 4 and after of "How to save the sender to contacts".
  - **Copy the selected number:** Press **4** to copy the number to the clipboard.
5. Press the  key to close the message.

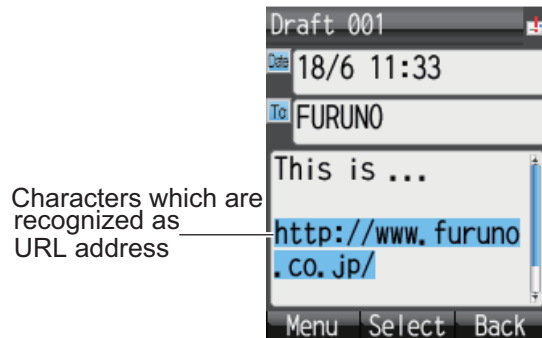

**URL**

1. Open the message with the included URL.
2. Press ▼ to select the URL. The URL is highlighted in light blue.

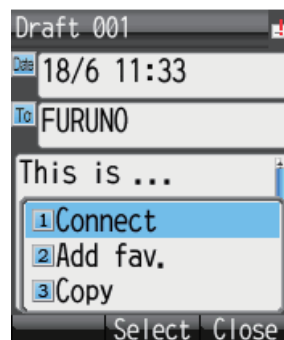

3. Press the **Enter** key to display the submenu.



4. The following operations are possible:
  - **Open and view the URL:** Press 1. Press ▲ to select [Yes] and press the **Enter** key. If the idle screen shows "D: Connected", the web page related to the URL appears (see paragraph 2.4.1). If "D: Not connected" (or "No permission") is shown, an error message appears and the web page is not shown.
  - **Save the URL to Favorites:** Press 2. With the [Title] field selected, press the **Enter** key. Enter a title in the field and press the **Enter** key. Press the  key to save to Favorites.
  - **Copy the URL:** Press 3. The URL is copied to the clipboard.
5. Press the  key to close the message.

## 2.4 Web

You can view web pages on the handset by using Standard IP (Best effort) packet communications service. Service charge is based on the amount of data volume, not connection time.

**Note:** The handset can start from Standard IP packet service. However, when using Streaming IP data packet service with the Web Software, the handset uses streaming IP service. The charge for Streaming IP service is based on connection time, so it is not advised to view web pages from the handset. Disconnect from the internet and re-connect to use Standard IP.

### 2.4.1 How to connect/disconnect to/from the Internet

**Note:** If the IP address of the handset is not set by web software (the standby display shows "D: No permission"), you cannot connect to the internet. See page 6-16.

#### How to connect to the Internet

If you are already connected to the Internet via the Web software (Idle screen displays "D: Connected"), the following procedure is NOT necessary.

Do the following to connect to the Internet:

1. At the idle screen, press the  key to open the [Web top] menu.

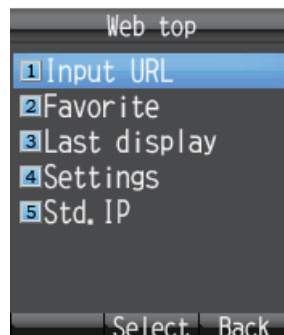

2. Press **5** to select [Std. IP].





3. Press **▲** to select [Yes], and press the **Enter** key. While connecting, the message "Connect..." appears. When connected, the message "Completed." is displayed. **Note:** If connection cannot be established, the message "Failed." appears.
4. Press the  key to close the menu. The idle screen now displays "D: Connected".

### How to disconnect from the internet

Do the following to disconnect from the internet. This operation disconnects all service types (Standard IP Packet, Streaming IP packet).

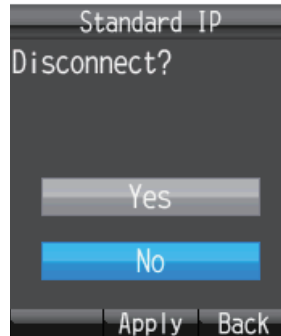
1. At the idle screen, press the  key to open the [Web top] menu.
2. Press the **5** key to select [Std. IP]. The following screen appears.



3. Press **▲** to choose [Yes], and press the **Enter** key. While disconnecting, the message "Disconnect..." appears and the message "Completed." appears when disconnection is completed.
4. Press the  key to close the menu. The idle screen now displays "D: Not connected".

### 2.4.2 How to view a web page

There are four ways to view a web page:

- Direct input of URL
- Use Input history
- Select URL from Favorites
- Use last-displayed URL

Confirm that the idle screen shows "D: Connected" then do the procedure shown below. If "D: Not connected" (or "D: No permission") appears an error message appears and the web page is blank.

### Direct input of URL

1. At the idle screen, press the  key to open the [Web top] menu.
2. Press **1** to select [Input URL].

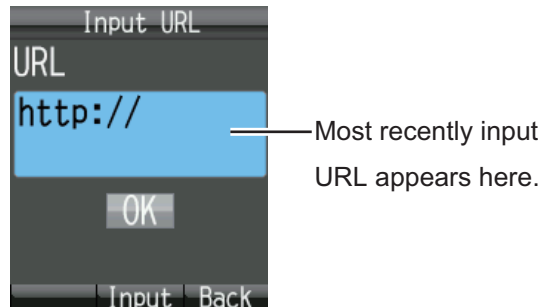

3. Press the **Enter** key to show the URL input screen.
4. Enter the URL address (maximum 192 characters), and press the **Enter** key. Any character, except a space, can be entered. If the most recently accessed web address appears in the field, press the **CLR** key to erase.



5. Press **▼** to choose [OK], and press the **Enter** key. The URL web page appears in the web browser. Use the [Web settings] menu to adjust the display for easy viewing. Refer to paragraph 3.4.



6. Press the  key to close the browser.





7. Press **▲** to select [Yes], and press the **Enter** key.

**Note:** You remain connected to the internet even if the browser is closed. See section 2.4.1 for how to disconnect from the internet.





### How to open a URL from the Input history screen

This procedure is invalid if the input history is empty.

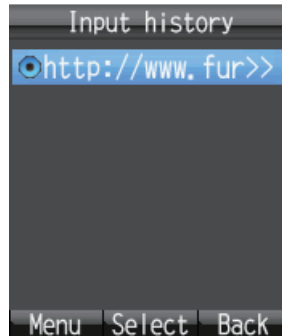
1. At the idle screen, press the  key to open the [Web top] menu.
2. Press **1** to select [Input URL].
3. Press the  key to show the submenu.  
Previously input URLs (maximum 10) are shown. When the 11th URL is added, the oldest URL is automatically deleted.



4. Press **▲** or **▼** to select a URL.  
**Note:** You can show the complete URL for the selected URL by pressing , then **1**, to select [Detail]. Press the  key to return to the Input history screen.
5. Press the **Enter** key. Selected URL appears in the [URL] field.
6. Press **▼** to select [OK], and press the **Enter** key. The web page appears.
7. Press the  key to close the browser.
8. Press **▲** to select [Yes], and press the **Enter** key.

### How to delete a URL from the history

1. Open the history. Go to step 2 to delete individual URL, or step 3 for all URLs.
2. Press **▲** or **▼** to select the URL to delete.
3. Press the  key to show the submenu.

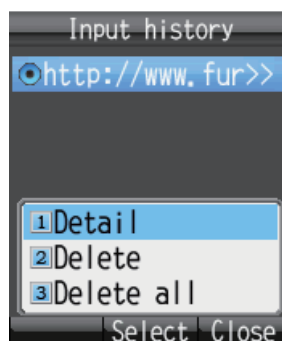

4. To delete individual URL, press **2** to select [Delete]. To delete all URLs, press **3** to select [Delete all]
5. Press **▲** to select [Yes] then press the **Enter** key.



### **How to view URL from the Favorite list**

If there are no items on the Favorite list, the message "no list" displays, and the following procedure is invalid.

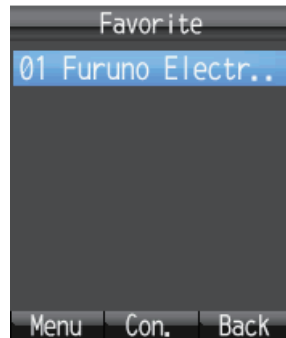
1. At the idle screen, press the  key to open the [Web top] menu.
2. Press **2** to select [Favorite] to show the Favorite list (maximum 10 favorites).





3. Press **▲** or **▼** to select the title.

**Note:** With the title selected, press the  key, then **1**(Det./Edit), to show the detailed information screen. The title and the URL appear. Press the  key to edit the title and the URL. Press the  key to return to the Favorite list.

4. Press the **Enter** key. The web page appears.
5. Press the  key to close the browser.
6. Press **▲** to select [Yes] and press the **Enter** key.

### **How to view most recent web page**

Data from the most recently viewed web page is temporarily saved to the memory, called a "cache". When viewing the same web page again, the data saved in the cache appears. If there is no data in the cache, the following operation is not possible.

1. At the idle screen, press the  key to open the [Web top] menu.
2. Press **3** to select [Last display]. The most recently viewed web page appears.
3. Press the  key to close the browser.
4. Press **▲** to select [Yes], and press **Enter** key.

### 2.4.3 Operations while viewing a web page

While viewing a web page, press the  key to open the submenu. The following operations are available:

- **1** (Back): Return to previous web page (if data is in cache).
- **2** (Forward): Advance to next web page (if data is in cache).
- **3** (Entry fav.): Save current page to Favorite list.
- **4** (Reload): Reload the current web page.
- **5** (Favorite): Display the Favorite list.
- **6** (Input URL): Manually enter a URL.
- **7** (Settings): Display the [Web settings] menu (see paragraph 3.4).

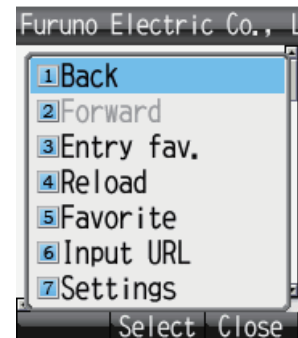

#### **About HTTPS sites**

If connecting to HTTPS site, the following screen is shown.



Select from the following choices, and press the **Enter** key to select.

- **Yes**: Authenticate the server certificate and display the https site.
- **No**: Do not authenticate the server certificate and close the pop-up screen.
- **Confirm**: Show the server certification details. Press the **Enter** key to authenticate, or the  key to refuse.

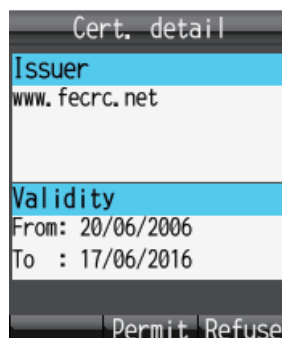

## 2.4.4 Favorite list



### How to add a URL to the Favorite list while viewing the list

Add often-accessed web pages to the Favorite list for easy viewing. The Favorite list stores 10 URLs. Do the following to register pages to the favorite list:

**Note:** If there are already 10 pages in the Favorite list, it is not possible to add another without deleting one.

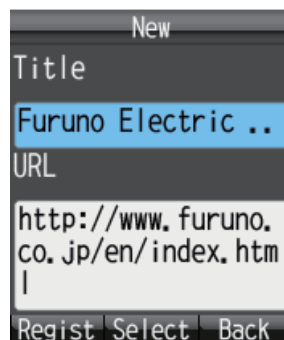
1. While viewing a web page, press the  key to open the submenu.
2. Press **3** to select [Entry fav.]. The title and URL of the web page appear in the [Title] and [URL] fields as shown below. For websites that are not in alphanumeric characters, the title must be manually entered. Go to step 3.





3. Select the [Title] field and press the **Enter** key.
4. Enter the title in alphanumeric characters and press the **Enter** key (max. 50 characters).
5. Press the  key. The message "Registered" appears and the URL is registered to the Favorite list.
6. Press the  key to close the browser.
7. Press **▲** to select [Yes], and press the **Enter** key.

**How to delete an item from the Favorite list**

You can delete one item, or all items, from the Favorite list as follows:

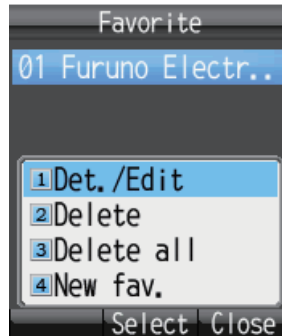
1. Open the Favorite list. To delete one item, go to step 2, and to delete all items, go to step 3.
2. Press ▲ or ▼ to select the item to delete.
3. Press the  key to open the submenu.



4. To delete one item, press **2** (Delete). To delete all items, press **3** (Delete all).
  - For **2**: Press ▲ to select [Yes] and press the **Enter** key.
  - For **3**: Press the **Enter** key. Enter the operation password and press the **Enter** key. Press ▼ to select [OK] and press the **Enter** key. Press ▲ to select [Yes], and press the **Enter** key.
5. Press the  key to close the Favorite list.

## 2. HANDSET OPERATIONS

This page is intentionally left blank.

# 3. SETTINGS FOR HANDSET

This chapter describes the menus [Sound], [Display], [SMS], [Web], and [Settings]. Also described are system messages from connected equipment, list of connected equipment, and how to display various information.

## 3.1 Sound Menu

The [Sound] menu sets options for internal and external phones, message notification for SMS messages and system messages, key beep, and microphone volume.

1. At the idle screen, press the **Enter** key to show the main menu.
2. Press **▶** to select the [Sound] icon, and press the **Enter** key to show the [Sound] menu.

**Note:** The [Sound] menu can also be opened by pressing the  key at the idle screen.

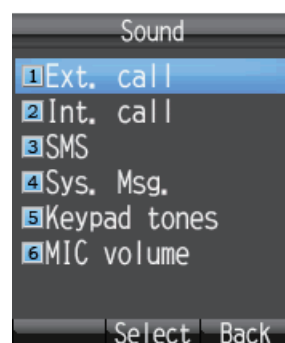

### 3.1.1 Notification sound setting



You can set the sound volume and ring pattern for internal and external phones and notification for SMS messages and system messages.

#### How to set the volume

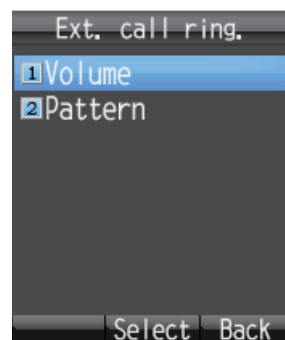
1. In the [Sound] menu, press either the **1**, **2**, **3**, or **4** key for the following items:
  - 1: External phone incoming notification volume
  - 2: Internal phone incoming notification volume
  - 3: SMS message notification volume
  - 4: System message notification volume



2. Press **1** to select [Volume] to show the below-right figure.
3. Press **▲** or **▼** to adjust the volume level (0 - 7). Set to [0] for no sound.

**Note:** Press the  key to hear the ringtone at the selected volume. Press the  key again to stop the ringtone.

4. Press the **Enter** key.
5. Press the  key to close the menu.



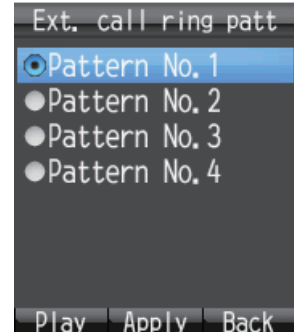

### How to set the ring pattern

1. In the [Sound] menu, press either the **1**, **2**, **3**, or **4** key for the following:
  - 1: External phone incoming notification pattern
  - 2: Internal phone incoming notification pattern
  - 3: SMS message notification pattern
  - 4: System message notification pattern
2. Press **2** to select [Pattern] to show the pattern selection screen.



3. Press **▲** or **▼** to select the pattern.

**Note:** Press the  key to play the pattern at the selected pattern. Press **▲** or **▼** to adjust the volume, from 1 - 7 and off. Press the  key to stop.
4. Press the **Enter** key.
5. Press the  key to close the menu.

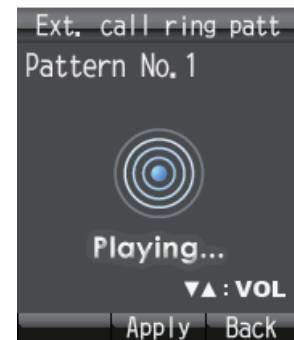

### 3.1.2 How to adjust keypad tones volume

To adjust the volume for the keypad tones, do the following:

1. In the [Sound] menu, press **5** to select [Keypad tones].
2. Press **▲** or **▼** to select the volume level.
3. Press the **Enter** key.
4. Press the  key to close the menu.

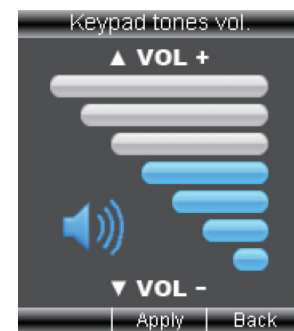

### 3.1.3 How to adjust the volume for the microphone

1. Press **6** to select [MIC volume] from the [Sound] menu to show the MIC volume setting window.
2. Press **▲** to increase the volume, or **▼** to decrease the volume (setting range: 1 to 7).
3. Press the **Enter** key.
4. Press the  key to close the menu.

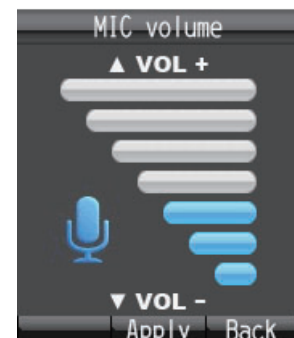



## 3.2 Display Settings

Change font size, LCD backlight, and key backlight from the [Display] menu.

1. At the idle screen, press the **Enter** key to open the main menu.
2. Press ◀ to select the [Display] icon, and press the **Enter** key to shown the [Display] menu.

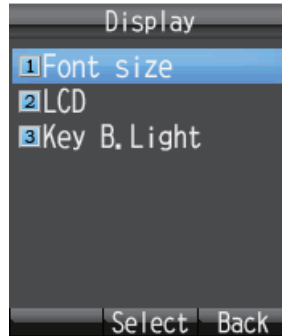

### 3.2.1 How to change the font size

Select the font size to other than that selected for web page.

1. In the [Display] menu, press **1** to select [Font size] to show the Font size screen.

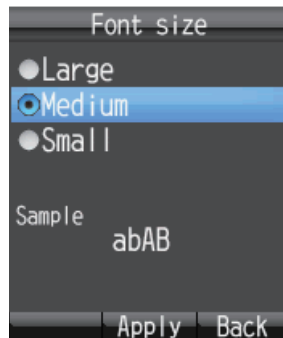

2. Press ▲ or ▼ to select font size ([Large], [Medium] or [Small]). The font size is shown in the [Sample] area.
3. Press the **Enter** key.
4. Press the  key to close the menu.

### 3.2.2 How to change LCD brightness and backlight ON time

Change the LCD brightness and backlight ON time as follows:

#### Brightness

1. In the [Display] menu, press **2** to select [LCD] to show the [LCD] menu.



2. Press **1** to select [Brightness] to show the brightness level screen.



3. Press ▲ or ▼ to increase / decrease the LCD brightness level.
4. Press the **Enter** key.
5. Press the  key to close the menu.

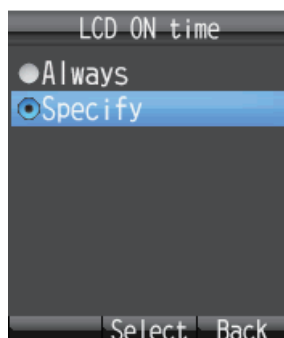

#### LCD Backlight ON time

1. In the [Display] menu, press **2** to select [LCD] to show the [LCD] menu.
2. Press **2** to select [LCD ON time] to show the [LCD ON time] screen.

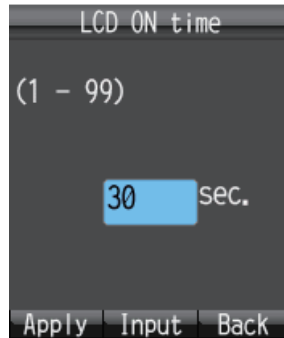

- Press ▲ or ▼ to select either [Always] or [Specify] and press the **Enter** key.  
**[Always]**: Keep the LCD light always on. Go to step 6. **[Specify]**: Enter a time limit for the backlight. If there is no key operation during the time limit, the LCD backlight automatically turns off. Go to step 4.





- If you selected [Specify] at step 3, press the **Enter** key and enter a time limit (1 - 99 sec.), and press the **Enter** key. The time is set.
- Press the  key.
- Press the  key to close the menu.

### 3.2.3 How to adjust the keypad backlight

Change the keyboard backlight settings.

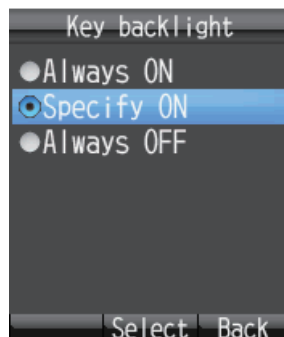
- In the [Display] menu, press **3** to select [Key B.Light] to show the [Key backlight] screen.



- Press ▲ or ▼ to select one of the following and press the **Enter** key.  
**[Always ON]**: The keyboard backlight is always illuminated. Go to step 6.  
**[Specify ON]**: The keyboard backlight stays illuminated for the set time. Go to step 3.  
**[Always OFF]**: The keyboard backlight is not illuminated. Go to step 6.
- Press the **Enter** key, and the character input screen appears.
- Enter illumination time (1 -99 sec.) and press the **Enter** key.
- Press the  key.
- Press the  key to close the menu.

### 3.3 SMS Settings

You can change your signature and password settings in the [SMS Settings] menu.

1. At the idle screen, press the **Enter** key to open the main menu.
2. Press **▲** to select the [SMS] icon and press the **Enter** key to show the [SMS] screen.

**Note:** The [SMS] menu can also be opened by pressing the  key at the idle screen.

3. Press **6** to select [Settings] to open the [SMS settings] menu.

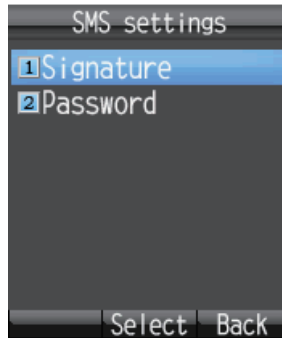

#### 3.3.1 How to set an SMS Signature

An SMS signature is a line of text that is added to the end of all outgoing messages. To add a signature to all outgoing messages, do the following:

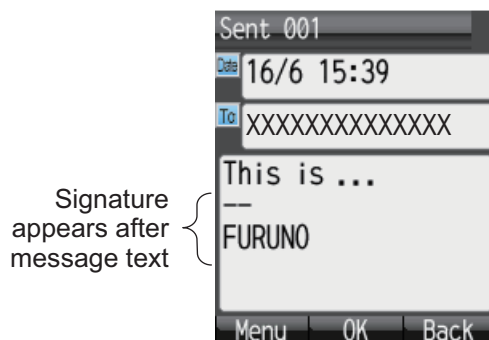

1. In the [SMS Settings] menu, press **1** to select [Signature].
2. Press **▲** or **▼** to select [ON] or [OFF] and press the **Enter** key.  
**[ON]:** A signature is automatically added to all SMS messages (go to step 3).  
**[OFF]:** A signature is not automatically added to SMS messages (go to step 4).
3. Enter the signature text (maximum 156 characters) and press the **Enter** key. For example, if "FURUNO" is entered as the signature, the sent message looks like the one shown below.



4. Press the  key to close the menu.

### 3.3.2 How to activate the SMS password

To activate the SMS password, do as follows.

1. In the [SMS settings] menu, press **2** to select [Password].
2. Press **▼** to select [Save password].
3. Press the **Enter** key to delete the checkmark [✓] from the check-box.
4. Press the  key.
5. Press the  key to close the menu.

After this, the SMS password is requested when you access the [SMS] menu.

## 3.4 Web Settings

The [Web settings] menu allows you to set features of the Web browser: font size, display zoom, display mode, advanced settings, time out, and clear the cache. To access the [Web settings] menu do the following:

1. At the idle screen, press the **Enter** key to open the main menu.
2. Press **▲**, then **◀** to select the [Web] **icon** and press the **Enter** key to show the [Web top] menu.  
**Note:** You can also show the [Web top] menu at the idle screen by pressing the  key.
3. Press **4** to select [Settings] to display the [Web settings] menu.

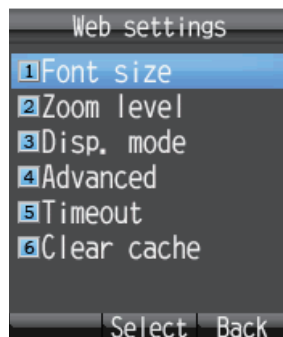

### 3.4.1 How to change web browser font size

1. In the [Web settings] menu, press **1** to select [Font size].
2. Press **▲** or **▼** to select font size ([Large], [Medium], [Small]). The font size is shown in the [Sample] area.
3. Press the **Enter** key.
4. Press the  key to close the menu.

### 3.4.2 How to change web page display zoom

You can change the display zoom factor to enlarge small print.

1. In the [Web settings] menu, press **2** to select [Zoom level] to show the [Zoom level] screen.

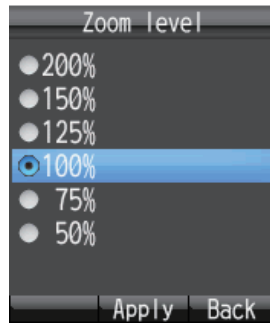

2. Press **▲** or **▼** to select a zoom level.
3. Press the **Enter** key.
4. Press the **Ⓞ** key to close the menu.

### 3.4.3 How to change web display mode

Display mode gives three different ways to display web pages:

- **[Normal]**: Display the web page at normal size (you need to scroll right and left to view).
- **[Just-fit]**: The width of the web page including tables is shrunk to fit the screen width.
- **[Smart-fit]**: The width of the web page is shrunk to fit the width of the screen. A table that is larger than the width of the display is split vertically.

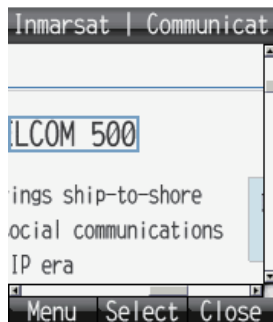

Normal

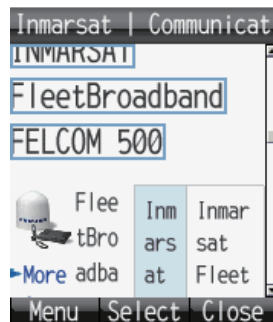

Just-fit

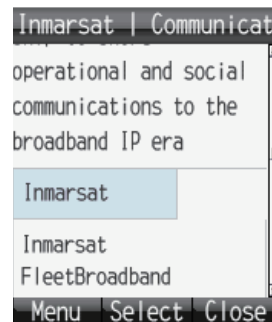

Smart-fit

To change the display mode, do the following:

1. In the [Web settings] menu, press **3** to select [Disp. mode] to show the [Display mode] screen.

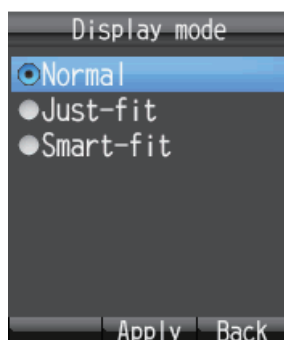



2. Press ▲ or ▼ to select [Normal], [Just-fit] or [Smart-fit].
3. Press the **Enter** key to select.
4. Press the  key to close the menu.

### 3.4.4 Advanced settings

Display image, Javascript and Popup window options can be set in Advanced Settings.

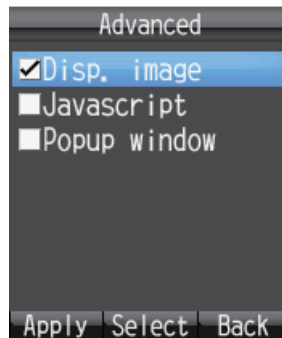
- **[Display Image]:** Display or do not display images when viewing web pages. Uncheck to display pages without images.
  - **[Javascript]:** Turn Javascript on or off when viewing web pages. Insert the checkmark to correctly view pages that use javascript.
  - **[Popup window]:** Block or allow popup windows when viewing web pages. Insert the checkmark to block popup windows.
1. In the [Web settings] menu, press **4** to select [Advanced] to show the [Advanced] screen.



2. Press ▲ or ▼ to select the item to edit.
3. Press the **Enter** key to insert or remove a [✓] in the box corresponding to each item.
4. Press the  key to apply settings.
5. Press the  key to close the menu.

### 3.4.5 How to set time out

Set the period of no activity before the handset disconnects from the Web. The default setting is 30 seconds. To change the Timeout setting, do the following:

1. In the [Web settings] menu, press **5** to select [Timeout] to show the [Timeout] screen.

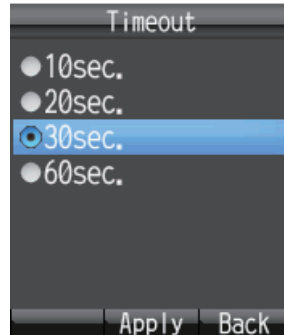

2. Press **▲** or **▼** to select a time.
3. Press the **Enter** key to set.
4. Press the **⌂** key to close the menu.

### 3.4.6 How to clear the cache

The Cache is a section of memory where downloaded information is stored temporarily. If the Cache becomes full, the oldest data is deleted automatically. To manually clear all of the data in the cache, do the following:

1. In the [Web settings] menu, press **6** to select [Clear cache] to show the [Clear cache] screen.

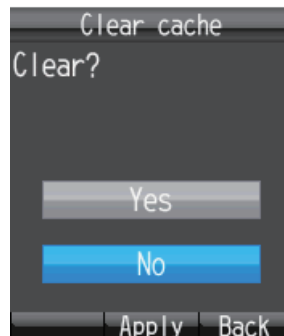

2. Press **▲** to select [Yes] and press the **Enter** key.
3. Press the **⌂** key to close the menu.



## 3.5 Individual Settings Menu

Basic (settings), Network, SIP, Operation Password, Initialization and Self test can be accessed from the [Settings] menu. Initialize and Self test are explained in Chapter 7.

The communication unit contains the following server functions:

- DHCP Server
- DNS Server
- NTP Server
- IMAP Server (for SMS)
- SIP Server (for telephone)

1. At the idle screen, press the **Enter** key to open the main menu.
2. Press ▼ to select the [Settings] icon and press the **Enter** key to show the [Settings] menu.

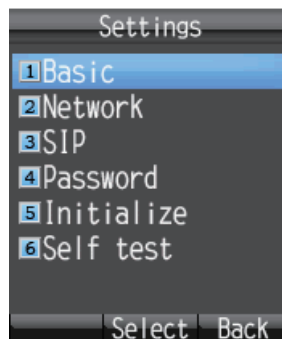

### 3.5.1 Basic settings

Sound, Display, Clock, Notify, Quick call and Echo Cancel can be set from the [Basic] menu. [Sound] can also be accessed by pressing the  key at the idle screen, or select [Sound] from the main menu (see paragraph 3.1). [Display] can also be accessed by selecting [Display] from the main menu (see paragraph 3.2).

#### How to set the clock

GPS time data is fed from the communication unit. If you change the IP address of the communication unit, do as follows to get data from the communication unit. The Clock setting in this procedure is for manual setting of the clock. For Automatic, this procedure is not necessary since the IP address of the communication unit is automatically changed.

1. In the [Settings] menu, press **1** to open the [Basic] menu.

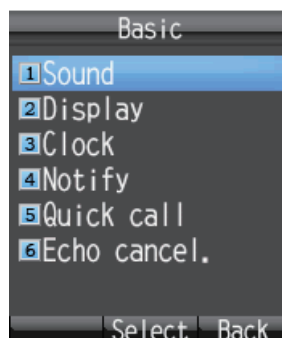

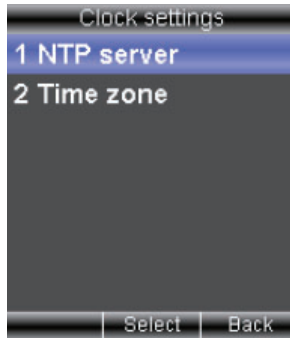

### 3. SETTINGS FOR HANDSET

2. Press **3** to select [Clock] and show the [Clock settings] screen.

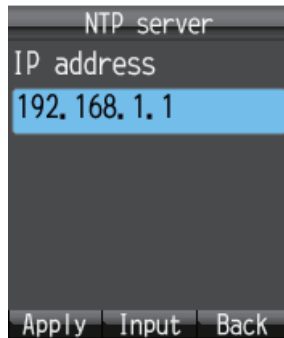

3. Select [NTP server] then press the **Enter** key.
4. Press **▼** to select Manual then press the **Enter** key to show the NTP server IP address input screen.



5. Select [IP address] then press the **Enter** key to show the IP address entry screen.
6. Enter the IP address (maximum 15 characters) of the communication unit then press the **Enter** key.
7. Press the  key to apply the setting.
8. Press the  key to close the menu.

**Note:** The time displayed on the handset can be adjusted to show local time. Use the following procedure to enable UTC time offset.

1. In the [Settings] menu, press **1** to open the [Basic] menu.
2. Press **3** to select [Clock] and show the [Clock settings] screen.
3. Select [Time zone] then press the **Enter** key.
4. Press **▲** or **▼** to adjust the UTC offset as required then press the **Enter** key.



19:17 — Displayed handset time changes with UTC adjustments

5. Press the  key to close the menu.

**Note:** The UTC offset settings are only applied to individual handsets. To apply the setting to other handsets, repeat the procedure for each handset.

### How to set call and message notifications

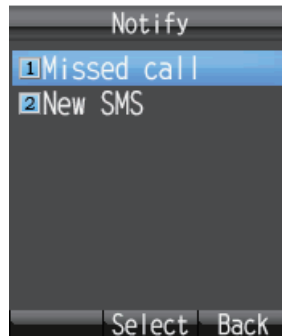

Set the notifications for missed call and received messages at the [Notify] screen. Notifications can be set to appear as icons (☎ / ✉) on the upper part of the screen and as a window message, or as icons with no window message.

1. In the [Settings] menu, press **1** to select [Basic] to show the [Basic] menu.
2. Press **4** to select [Notify] to show the [Notify] screen.

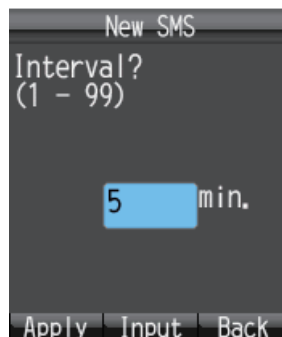

3. For missed call notification setting, press **1** to open the [Missed call] screen. For received message notification setting, press **2** to open the [New SMS] screen.
4. To set notifications as both icons and a window message, set to [ON]. If you don't need to display the window message and icon, set to [OFF].
5. Press the **Enter** key.  
If you select [ON] at the above step, the following [New SMS] window appears. Go to step 6.  
If you select [OFF], go to step 9.



6. Press the **Enter** key to open the input screen.
7. Enter the check interval (1 - 99 minutes) and press the **Enter** key.  
This sets the length of time to access the SMS server to check a new message. If there is a new message, the icon and the message window are displayed.
8. Press the  key.
9. Press the  key to close the menu.



### 3. SETTINGS FOR HANDSET

#### How to set Quick Off hook

When quick off hook is set to ON, to take the handset off the cradle has the same effect as to press the  key (phone answers automatically).

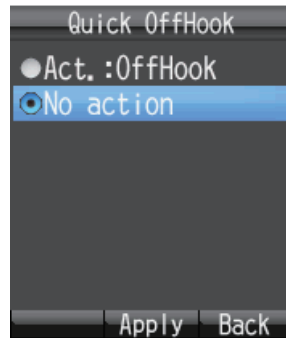
1. In the [Settings] menu, press **1** to select [Basic] to show the [Basic] menu.
2. Press **5** to select [Quick call] to display the [Quick OffHook] screen.





3. Press **▲** or **▼** to choose setting for off hook:  
[**Act.: OffHook**]: Removing the handset from the cradle has the same result as to press the  key.  
[**No action**]: Removing the handset from the cradle has no effect.
4. Press the **Enter** key.
5. Press the  key to close the menu.

#### How to set the echo canceller

If the echo canceller is off, you may hear the delayed echo of your own voice in the handset. Turn the echo canceller on to suppress the echo of your own voice. Do the following to turn echo canceller on or off:

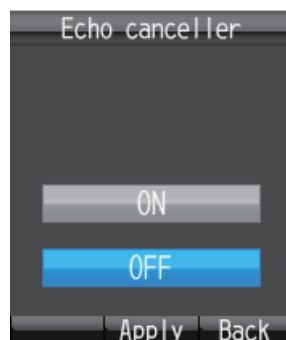
1. In the [Settings] menu, press **1** to select [Basic] to show the [Basic] menu.
2. Press **6** to select [Echo cancel.]. You are asked to enter the operation password.
3. Press the **Enter** key.
4. Enter the operation password. Press the **Enter** key.
5. Press **▼** to select [OK] and press the **Enter** key to show the [Echo canceller] screen.



6. To turn on [Echo canceller], select [ON]. To turn off [Echo canceller], select [OFF].
7. Press the **Enter** key.
8. Press the  key to close the menu.

### 3.5.2 Network settings

Network settings can be set automatically or manually.

1. In the [Settings] menu, press **2** to open the [Network] menu. You are asked to enter the operation password.
2. Press the **Enter** key.
3. Enter the operation password and press the **Enter** key.
4. Press **▼** to select [OK] and press the **Enter** key to show the [Network] menu.

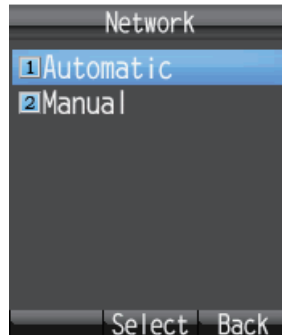

5. To have settings detected automatically, press **1** to select [Automatic]. To enter settings manually, press **2** to select [Manual]. For [Automatic], go to step 24. For [Manual], go to step 6.



6. Press **1** to select [IP obtain] to show the [IP obtain] screen.

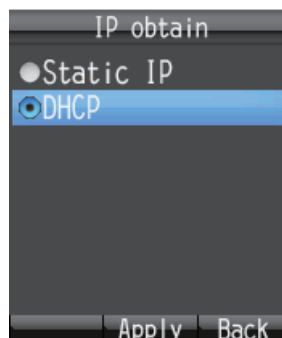

7. Press **▲** or **▼** to select the method for obtaining the IP address.  
**[Static IP]:** The IP address, subnet mask and default gateway are set manually.  
**[DHCP]:** The IP address, subnet mask and default gateway are obtained automatically from the DHCP server.
8. Press the **Enter** key. Do one of the following depending on selection made at step 7.  
 If you select the [Static IP] at step 7, the [Static IP] screen appears. Go to step 9.

### 3. SETTINGS FOR HANDSET

If you select the [DHCP] at the step 7, the [Manual set.] screen appears. Go to step 16.

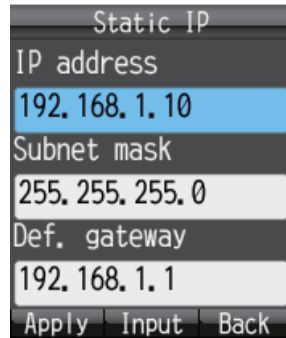

*Static IP factory default settings*

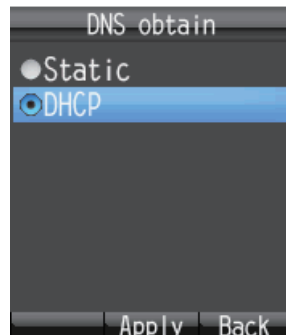

9. With the [IP address] field selected, press the **Enter** key.
10. Enter the IP address for this unit, and press the **Enter** key.
11. Press ▼ to select the [Subnet mask] field, and press the **Enter** key.
12. Enter the Subnet mask and press the **Enter** key.
13. Press ▼ to select the [Def. gateway] field, and press the **Enter** key.
14. Enter the default gateway (IP address of the router) and press the **Enter** key.
15. Press the  key to return to the [Manual set.] menu.
16. Press **2** to select the [DNS] menu to show the [DNS obtain] screen.

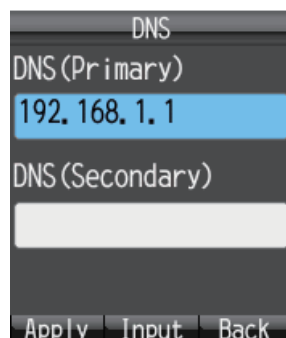

17. Press ▲ or ▼ to select the method for obtaining the DNS server address.  
[Static]: Set Primary and Secondary DNS server addresses manually.  
[DHCP]: Obtain DNS server address automatically from the DHCP server.
18. Press the **Enter** key. Do one of the following depending on selection made at step 17.  
If you select the [static] at step 17, the DNS entry screen appears. Go to step 19.  
If you select the [DHCP] at step 17, the [Manual set.] screen appears. Go to step 24.



*DNS factory default settings*

19. With the [DNS (Primary)] field selected, press the **Enter** key.
20. Enter the IP address of the primary DNS server and press the **Enter** key.
21. Press ▼ to select the [DNS (Secondary)] field, and press the **Enter** key.
22. Enter the IP address of the secondary DNS Server and press the **Enter** key.  
**Note:** If only the Secondary DNS Server address is entered, the Primary DNS is set to the same value.
23. Press the  key to return to the [Manual set.] menu.
24. Press the  key to close the menu.

### 3.5.3 SIP settings

This section describes SIP server settings. Do the procedure if it is necessary to enter SIP settings.

1. In the [Settings] menu, press **3** to select [SIP] to show the [SIP] menu.

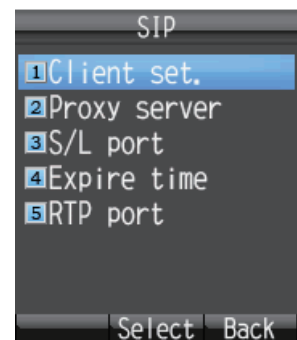

2. Press one of keys **1 -5** depending on your objective.
  - 1:** Set SIP client.
  - 2:** Set SIP proxy server.
  - 3:** Set SIP server port number.
  - 4:** Set SIP server authentication interval.
  - 5:** Set RTP port.
3. Set SIP by referring to the descriptions in the table.

Menu	Item	Description
Client set.* <sup>1</sup>	Phone number	Enter extension number (1000 - 9999).
	Password	Enter SIP password. Up to a maximum of eight alphanumeric characters (upper case alphabet only) can be used. This password is for identification at the SIP server.
	Nickname	Enter a nickname (maximum of 50 alphabet). The nickname appears on the display of the called extension handset.
Proxy server* <sup>2</sup>	Automatic	The IP address (IP address of communication unit) of the SIP proxy server is automatically changed.
	Manual	Enter the address (IP address of communication unit) of the SIP proxy server manually.
S/L port	Server port	Enter server port number (0 - 65535).
	Local port	Enter local port number (0 - 65535).
Expire time	-	Enter expiration time (1800 - 7200 (sec.)).
RTP port* <sup>3</sup>	RTP port 1	Enter RTP port 1 (16384 - 32766, even number only). Set different from RTP port 2.
	RTP port 2	Enter RTP port 2 (16384 - 32766, even number only). Set different from RTP port 1.

### 3. SETTINGS FOR HANDSET

\*1: To change both extension number and SIP password at the [Client set.] menu, you must also change a setting of the Web software at the SIP server. (See page 6-4.) The telephone functions cannot be used if the settings for SIP client and SIP server are different.

\*2: The IP address of the SIP proxy server must be the same as the IP address of the communication unit in order to use the telephone function.



\*3: For connection of multiple handsets, enter a different numbers for RTP port 1 and RTP port 2 of all handsets. Entering the same numbers disables the multi voice function.

#### 3.5.4 How to change operation password for the handset

Do this procedure to change the operation password. After entering a new password be sure to write it down. If the password is lost, contact your dealer to restore factory settings. If this occurs, the default settings must be restored. (See section 7.7).

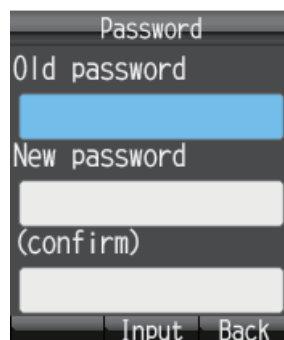
1. In the [Settings] menu, press **4** to select [Password] to show the [Password] menu.



2. With the [Old password] field selected, press the **Enter** key.
3. Enter the current password and press the **Enter** key. The entered characters are shown with asterisks (\*).
4. Press **▼** to select the [New password] field and press the **Enter** key.
5. Enter the new password (4 - 8 characters, upper case alphabet only) and press the **Enter** key.
6. Press **▼** to select the [(confirm)] field and press the **Enter** key.
7. Re-enter the same new password for confirmation and press the **Enter** key.
8. Press the  key. The message "Changed." appears and the equipment returns to the [Settings] menu.  
**Note:** If the password could not be changed, the message "Could not change" appears. Repeat this procedure.
9. Press the  key to close the menu.



## 3.6 System Messages

If an alarm occurs in a unit connected in the same network, the handsets sounds an alarm tone and an alert information window displays. The alarm icon (  ) also appears at the status bar on the upper part of the screen.

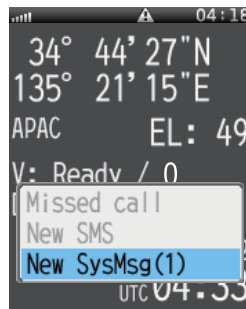

- 1) In the alert information window, select [New SysMsg] and press the **Enter** key. The most recent system messages appears. A maximum of 10 system messages can be saved, however the messages are erased when the power is turned off.

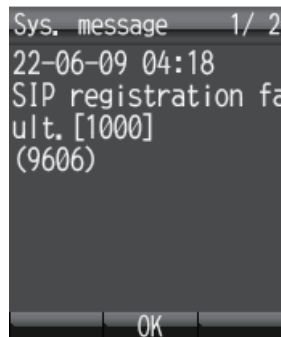

No. of messages/  
Total messages saved

- 2) If there are more than two alert messages, press **◀** and **▶** to cycle through the messages. Use **◀** to go back one message, and **▶** to go forward one message.
- 3) Press the **Enter** key to close the message.  
**Note:** You can also display system messages with the [Sys Msg] icon in the main menu.

## 3.7 Device List

The Device list displays a list of all devices (communication unit, handset, incoming indicator).

- 1) At the idle screen, press the **Enter** key to open the main menu.
- 2) Press **◀**, **▼** to select the [Device] icon and press the **Enter** key. The message "Detecting" appears while the list is being prepared. When the search is completed, the [Device list] screen appears.

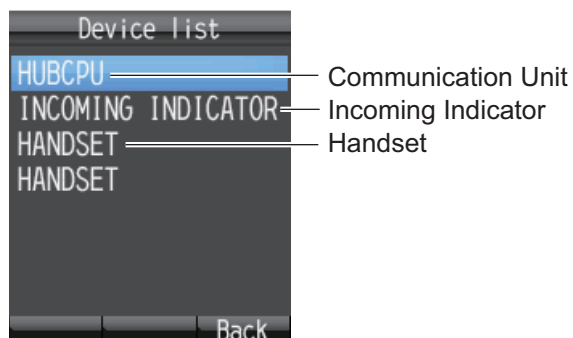

- 3) Press the  key to close the menu.

## 3.8 How to Show TCP/IP, SIP and Software Version information

Do as follows to see TCP/IP, SIP and software version information.

1. At the idle screen, press the **Enter** key to show the main menu.
2. Press **▶**, then **▼** to select the [Info] icon and press the **Enter** key to show the [Information] menu.



3. Press one of keys 1 - 3 to view information as follows:
  - 1: TCP/IP information
  - 2: SIP information
  - 3: Software version information of handset

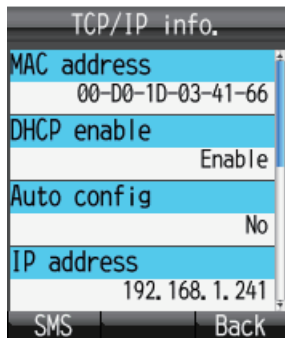

TCP/IP info

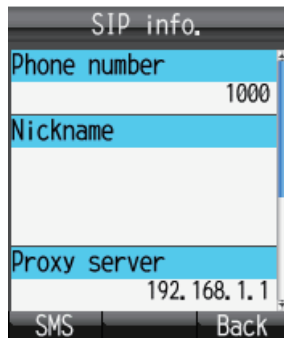

SIP info



Software info

XX: Program version no.

△△: Circuit board version no.

4. Press **▲** or **▼** to scroll through the screen to see the information.
5. Press the **⏏** key to close the menu.

**Note:** If you need to send the information by SMS, press the **Ⓜ** key to open the [Create SMS] screen.

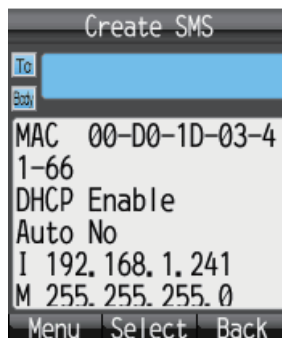

TCP/IP Info

## 4. OPTIONAL DEVICES

### 4.1 Fax (FAX-2840)

The optional FAX unit can send and receive faxes using 3.1kHz audio service from land or ship-to-ship.

**Note:** Depending on SIM card type, 3.1kHz audio service may not be available. Check with the company that issued your SIM card.

#### How to dial

##### To Land

Enter 2\*00, the Country Code, the fax number, followed by # and **Start** to send a fax.

##### Ship-to-ship

Enter 2\*00, 870 (ocean area code), followed by the Inmarsat number, # and **Start** to send a fax.

**Note 1:** In the Web software, if the analog port [Type] is set to [FAX] or [TEL & FAX], a Fax can be sent without entering [2\*] before the number. See the Installation Manual.

**Note 2:** When sending a FAX, the number that is printed on the sent fax sheet is the telephone number of your unit, not the FAX number. When replying to a FAX, be sure to ask the sender for their FAX number.

**Note 3:** When you send a fax from FELCOM 250/500 to FELCOM 30/50/70, always use a 3.1 KHz audio service number.

### 4.2 Incoming Indicator (FB-3000)

The Incoming Indicator sounds a buzzer and blinks its lamp when a telephone call, fax or ISDN (UDI/RDI, FELCOM 500 only) communication is received. Press the **ACK** button to stop the buzzer on the receiving fax. In the case of a phone call, press the **ACK** button to stop the buzzer on the receiving telephone, or the alarm automatically stops when the handset is removed from the cradle. Press the [▲] and [▼] buttons to raise and lower the alarm volume.

There are two selectable alarm types. The alarm can also be set to Off. (See the Installation Manual.)

**Note:** The buzzer volume will reset to maximum volume, regardless of user settings, every time the power is turned off and on.

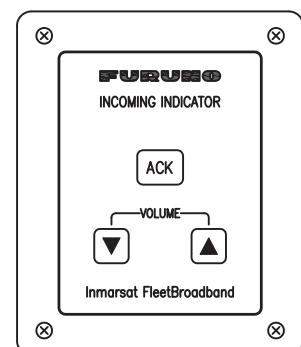

### 4.3 Incoming bell (FB-3001)

The incoming bell sounds a buzzer when a telephone call or fax is received. Move the switch to select one of the three following volume settings for the bell:

- Left: Mute
- Center: Low volume
- Right: High volume

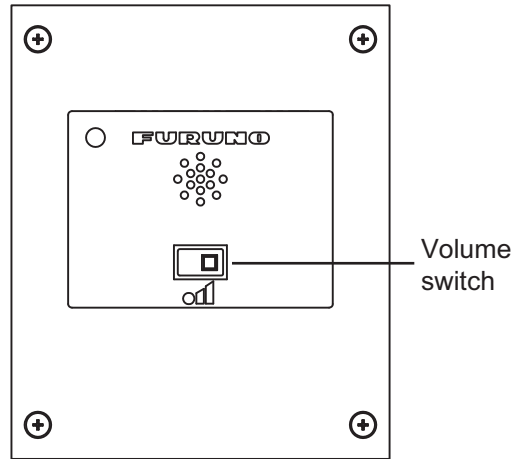

Incoming bell (FB-3001)

# 5. WEB SOFTWARE

---

The Web software makes a connection to Internet, adjusts the Communication Unit settings, creates SMS messages, and creates/edits the Contacts list. Connect the Communication Unit to a PC to use the Web software. The Communication Unit works with the following web browsers:

- Internet Explorer® version 6.x/7.x/8.x/9.x/10.x/11.x

**Note 1:** For version 8.x, disable the SmartScreen® filter (Safety button > SmartScreen® Filter > Turn Off SmartScreen® Filter > click OK button).

**Note 2:** For Windows 10® users, this software is not compatible with the Microsoft Edge® browser.

Use Internet Explorer® version 11.x to access the Web software.

To open Internet Explorer® 11.x, refer to the following URL:

<http://windows.microsoft.com/en-us/internet-explorer/pin-internet-explorer-start-taskbar#ie=ie-11-win-7> (URL valid at time of printing).

- Mozilla Firefox® version 3.x

## 5.1 How to Open/Close the Web Software

1. Make sure the SIM card is inserted. Turn the Communication Unit on.
2. Switch the PC power on.
3. After the computer starts, double-click the [FELCOM\_FB] icon on the desktop to start the Web browser.
4. Enter “192.168.1.1” in the address bar and press **Enter** key.  
The Main screen displays.

**Note 1:** If the following PIN Code entry screen appears, enter the PIN code of the SIM card. (See section 1.3.)

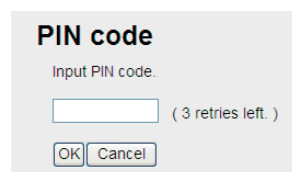

**PIN code**  
Input PIN code.  
 ( 3 retries left. )  
OK Cancel

**Note 2:** You can add the main menu of the Web software to “Favorite” or “Bookmark” for easy access.

5. To close the Web software, click the [X] (Close) button at the upper right corner of the window.

**Note:** If the system becomes overloaded while processing data, a CGI error may occur. If this occurs, wait a short amount of time and try again.

## 5.2 Screen Explanation

The screen is divide into several areas.

Menu bar

Status area

System message area

Administrator login/ logout button. (Refer to 5.9.1, 6.1.1)

Sub menu area

Information area

See "IMPORTANT NOTICES" (page i).

**FELCOM500**

34°44'24"N 135°21'12"E  
03-12-2012 01:50

(SIM)No SIM.

admin login

Main SMS Contacts SIM

**Status monitor**

**Status monitor**

**Tracking status**

Satellite	APAC
Channel / Status	Primary / Tracking
Satellite azimuth	165 [degrees]
Antenna elevation	59 [degrees]
Signal strength	56.1 [dB-Hz]

**Ship position information**

GPS in use	Internal
Latitude	34°44'24"N
Longitude	135°21'12"E

**Error information**

Error / Warning	0 / 0
-----------------	-------

**Communication status**

Voice & FAX / M!	Ready / 0
Data connection	Not connected
Data size	0 [KBytes]
Tx	0 [KBytes]
Rx	0 [KBytes]
Connection	0 (8kbps)

**Temperature information**

HPA	50.0 [degrees C]
IF	46.8 [degrees C]
Modem	50.4 [degrees C]

Copyright 2001-2011 FURUNO ELECTRIC CO., LTD.

### Status area

The status area displays the reception signal level, ship position information, date and time. Data is updated every 30 seconds.

Reception signal level (8 bars)

Ship latitude

Ship longitude

Date

Time

34°44'24"N 135°21'12"E  
03-12-2012 01:50

**System message area**

Error and Warning messages are displayed in red letters in the System message area (See section 7.6).

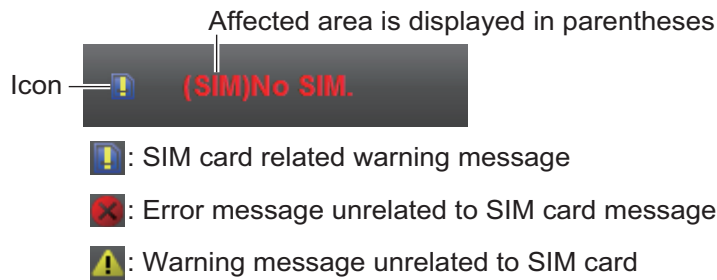

**Menu bar**

The menu bar contents are different when you are logged in or if you are logged out. Click a menu item with the mouse pointer to view the contents in the sub menu or information areas.

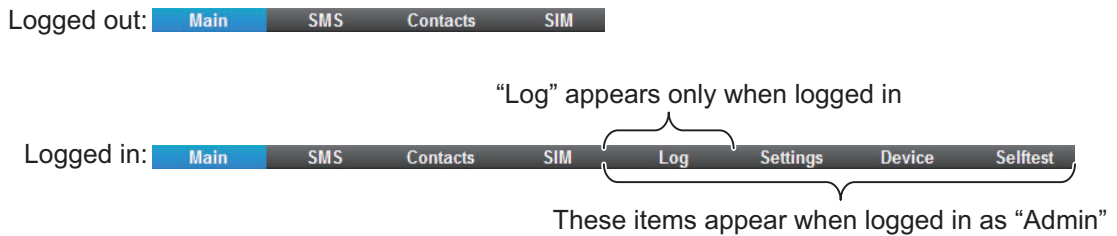

**Sub menu area**

In the menu bar, click [Main], [SMS], [Log], [Settings], [Device] or [Contacts] (displayed when logged in as Admin) to display respective menu in the sub menu area. Click an item in the sub menu to display its contents in the Information area. Click ▼ to expand the sub menu for more contents items. Click ▲ to close the expanded submenu.

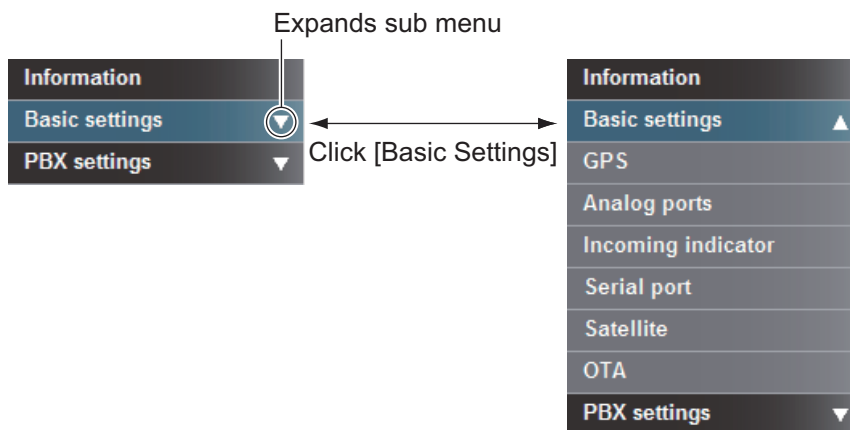

**Information area**

The information area displays current setting conditions and various information. Setting conditions can be changed from the menu.

## 5.3 Status Monitor

The Status monitor displays satellite tracking status, communication status, ship position information, Communication Unit internal temperature, and error information. Data is refreshed every five seconds. If the Status monitor is not displayed, do the following to view:

See "IMPORTANT NOTICES" (page i).

**Status monitor**

Tracking status		Communication status	
Satellite	APAC	Voice & FAX / MV	Ready / 0
Channel / Status	Primary / Tracking	Data connection	Connected
Satellite azimuth	165 [degrees]	Data size	23 [KBytes]
Antenna elevation	39 [degrees]	Tx	8 [KBytes]
Signal strength	63.7 [dB-Hz]	Rx	15 [KBytes]
Ship position information		Connection	1 (16kbps)
GPS in use	Internal	Temperature information	
Latitude	34°44'26"N	HPA	46.0 [degrees C]
Longitude	135°21'16"E	IF	47.0 [degrees C]
Error information		Modem	53.4 [degrees C]
Error / Warning	0 / 0		

1. Click [Main] in the menu bar.
2. Click [Status monitor] in the sub menu. The [Status monitor] appears as shown: Refer to the following table description of Status Monitor items:

Item	Description
<b>Tracking status: Satellite tracking information</b>	
Satellite	Name of Satellite that is being tracked.
Channel/Status	Channel: Displays the searching or tracking channel (Primary/Alternate). <ul style="list-style-type: none"> <li>Primary: First global channel frequency</li> <li>Alternate: Second global channel frequency</li> </ul> Status: Displays satellite tracking status. Searching (searching for satellite), Tuning (antenna fine tuning), Tracking (tracking satellite), Blocking (satellite signal is blocked).
Satellite azimuth	Displays satellite bearing, North as reference.
Antenna elevation	Displays antenna elevation angle.
Signal strength	Displays signal reception level in the modem.
Interference* <sup>1</sup>	"Detected" is displayed when interference signal is detected.
<b>Communication status: Communication information</b>	
Voice & FAX/ MV* <sup>4</sup>	Display voice communication status. --- (unavailable), Ready (Line is ready), Voice (Phone in use), Fax (Fax in use), UDI* <sup>2</sup> (ISDN UDI in use), RDI* <sup>2</sup> (ISDN RDI in use)
Data connection (FX)* <sup>5</sup>	Displays data communication status. --- (Not available), No permission (No connection permission), Not connected, Connected (in green). The status of all groups is shown if logged in as Administrator. "Connected" if one or more groups is connected; "Not connected" if no groups are connected. <b>Note:</b> With FX mode enabled, "Connected" or "Not connected" indications are displayed, regardless of login privileges.



Item	Description
Data size <sup>*3</sup>	Displays packet traffic volume of group affiliated with the PC currently in use. <b>Data size:</b> Total size of packets sent/received. <b>TX:</b> Total size of sent packages. <b>RX:</b> Total size of received packages. If logged in as Administrator, the packet volume for all groups/PP-PoE sessions is shown. If there is no satellite acquired “---” appears.
Connection <sup>*3</sup>	Displays Streaming IP packet session volume. The total for all groups is shown if logged in as Administrator.
<b>Ship position information</b>	
GPS in use	Displays GPS in use. Internal, External, No fix (GPS data invalid), No data (no GPS data)
Latitude	Displays ship latitude. If no GPS data, [ _ ° ' _ ”] is displayed.
Longitude	Displays ship longitude. If no GPS data, [ _ ° ' _ ”] is displayed.
<b>Temperature information: Internal temperature information</b>	
HPA	Temperature of the HPA board in the Antenna Unit. If no information, [---] is displayed.
IF	Temperature of the IF board in the Communication Unit. If no information, [---] is displayed.
Modem	Temperature of the modem board in the Communication Unit. If no information, [---] is displayed.
<b>Error information</b>	
Error / Warning	Number of Errors and Warnings generated.

\*1: No indication with non-XL equipment or when there is no interference.

(How to check the XL (extended L-band) applicable unit, refer to section 7.8.)

\*2: FELCOM 500 only.

\*3: No display if No permission is shown for Data connection.

\*4: See "IMPORTANT NOTICES" on page i.

\*5: “(FX)” displayed when FX mode is enabled.

## 5.4 Data Connection

There are two types of IP packet communication services:

Service	Description	Connection speed	Payment method	Use
Standard IP packet communication (Best effort packet)	Speed of the communication service is not guaranteed. Since the bandwidth is shared by many vessels, communication speed varies depending on the number of vessels that communicate at the same time.	<ul style="list-style-type: none"> <li>• Max. 284 kbps (FELCOM 250)</li> <li>• Max. 432 kbps (FELCOM 500)</li> </ul>	Fee based on amount of data	<ul style="list-style-type: none"> <li>• E-mail</li> <li>• Internet / Intranet</li> <li>• Update ship voyage information</li> <li>• Database search</li> <li>• Electronic trade</li> <li>• Web browsing</li> </ul>
Streaming IP packet communication	Provider guarantees connection speed.	Can select 8, 16, 32, 64, 128, 256 kbps (256 kbps FELCOM 500 only).	Fee based on connection time	<ul style="list-style-type: none"> <li>• Video conferences or moving picture delivery*</li> <li>• Transmit photographic data*</li> <li>• Streaming video*</li> </ul>

\*: The streaming IP packet communication method provides uninterrupted transmission of audio and video, provided you are within the guaranteed bandwidth. However, if you can accept broken audio and video, you can use the standard IP communication. When selecting which service to use, consider whether stable communication or communication fee is important.

**Note:** The cost of streaming IP packet communication may be unexpectedly high, so please use caution.

**How to connect to the internet**

Follow the procedure shown below to connect to the internet.

**Note 1:** You cannot connect to the internet if the main display of the web software shows “Data connection No permission”.

**Note 2:** You can connect to the internet via PPPoE. See page 6-39.

1. Click [Main] in the menu bar.
2. Click [Data connection] in the sub menu to show the following display.  
Your Data connection list looks something like the one shown below. This list shows the groups registered in the PC in use. See paragraph 6.1.9 for how to create the connection list. If you are logged in as Administrator, the [Disconnect all connection] button appears, which lets you disconnect all connections. The connection list for all group/PPPoE session\*/Bridge mode is shown.  
\* PPPoE session shown during data connection. The Application windows shows “---”.

Number of lines connected/total number of lines

		Service	Application	Connection Status		
<b>Data connection</b>						
Refresh						Connected : 0 / 11
Label	P/S	Service	Application	Status	Operation	
Default		Standard	Browser	Not Connected	Connect	
**		32kbps	WindowsMediaPlayer	Not Connected	Connect	
		64kbps	Browser	Not Connected	Connect	

Group name/PPPoE session name/Port name for Bridge mode registered to connection list

\*\* : Connection list

**Note:** The [Refresh] button updates the list.

3. Click the [Connect] button of the service to use. When connecting, the message "Now connecting..." displays. When connected, the message "\*\*\*connection success." appears.

**Note:** If connection fails, the message "\*\*\*connection failure." appears.

4. Click the [OK] button to close the message. The Status window shows “Connected” and the label on the button in the Operation window shows “Disconnect.”
5. To use multiple data services, repeat steps 3 - 4.

**Note:** It is not possible to use the same application that is already connected. Disconnect the service, and reconnect.

When connected to the internet, the connection list is displayed as shown:

Label	P/S	Service	Application	Status	Operation
Default	P	Standard	---	Connected	Disconnect
Default	S	32kbps	WindowsMediaPlayer	Connected	Disconnect
Default		64kbps	Browser	Not Connected	Connect

P Mark

S Mark

*Example: Standard IP packet, 32 kbps streaming IP packet communications*

- The first service for each group has a P mark, and "---" appears in the [Application] field. The second and subsequent service for each group has an S mark.

## 5. WEB SOFTWARE

In the above connection list, Standard IP Packet Data Connection Service is connected first.

- In the [Status] field, "Not connected" changes to "Connected" (displays in green).
  - The display in the [Operation] field changes from "Connect" to "Disconnect".
6. Open the desired application software and begin data communication. Applications are not limited to only those marked with the P mark (applications preset at paragraph 6.1.9.) You can use any software that appears after the 2nd application in the list. For example, when the connection list was as shown above, Windows Media<sup>®</sup> Player uses the 32 kbps streaming IP packet communication service and all other applications use the standard IP packet communication service.

### **How to disconnect from the internet**

Do the following to disconnect from the internet:

1. Click [Main] in the menu bar.
2. Click [Data connection]. The [Data connection] screen is displayed.
3. Click [Disconnect] for the services to disconnect. When disconnecting, the message "Now disconnecting..." is displayed. When disconnected, the message "\*\*\*\*disconnection success." is displayed. (\*\*\*: Service and application)  
**Note 1:** If you disconnect a service marked with a P mark, all other connected services will disconnect.  
**Note 2:** If the disconnection fails, "\*\*\*\*disconnection failure." is displayed.
4. Click the [OK] button to close the message. The [Status] field displays "Not Connected", the [Operation] button shows "Connect".

## 5.5 Contacts

Like the handset, you can add, edit and delete contacts from the Web software. Use the Web software to save contacts to the Communication Unit or SIM card.

Media	Maximum savable address count
Communication Unit	150 addresses
SIM card	Different with SIM card type

### 5.5.1 How to register contacts to the Contacts list

Save contacts (contact name and phone number) to the Contacts list as follows:

1. Click [Contacts] in the menu bar, to show the Contacts list screen. It takes approx. two minutes after powering on to display the list.

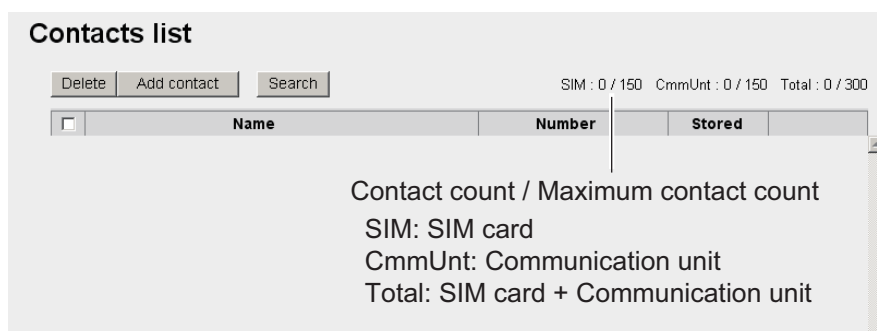

2. Click the [Add contact] button, to show the Contact list / Add contact screen.

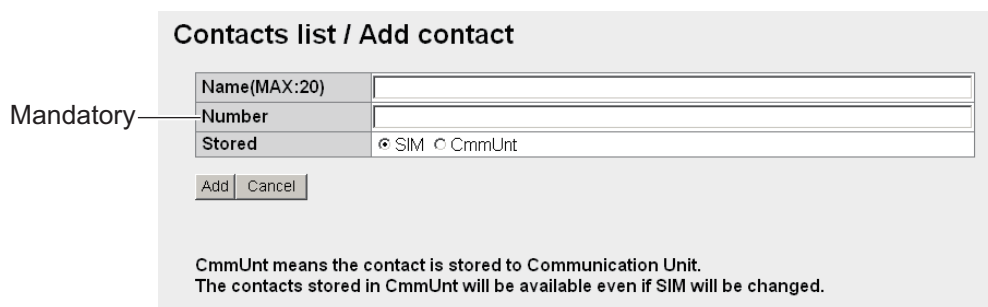

3. Input the name of the contact in the [Name] field. You may use alphanumeric characters and symbols, except those shown in the table below.

^	{	}	[	]
	\	~	;	,

The character limit depends on the type of media storage used. When you save a contact (at step 5) the number of characters that you can input is shown with "MAX: \*.\*"

4. Input the phone number in the [Number] field (Maximum 20 characters). Only numbers and the characters (#, \*, and +) are allowed.
5. Select where to save the address in the [Stored] field (CmmUnt: Communication unit, SIM: SIM card).
6. Click the [Add] button. When completed, the message "Completed." appears.
7. Click the [OK] button.

## 5.5.2 How to arrange the Contacts list

### How to sort the Contacts list

You can display your contacts in ascending/descending order of ASCII code order.

1. Click [Contacts] in the menu bar.
2. Click the [Name] field at the very top of the Contacts list. A ▲ (or ▼) symbol is displayed beside [Name].

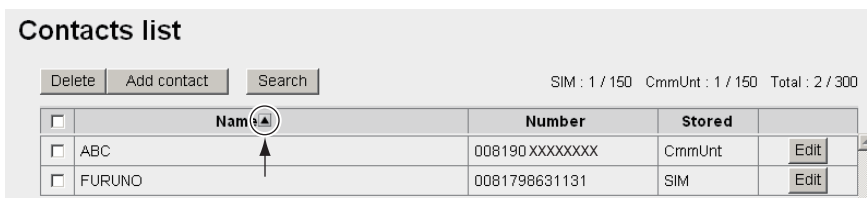

3. Click [Name] to toggle between ▲ and ▼.  
 If ▲: The contact names appear in ascending order (symbol, number, alphabet).  
 If ▼: The contact names appear in descending order (alphabet, number, symbol).

**Note:** Click [Number] at the top of the list to sort ascending or descending order for phone numbers.

### How to search for a contact

Enter a name or number to search for a desired contact.

1. Click [Contacts] in the menu bar.
2. Click [Search] button in the Contacts list to show the search bar.  
 Click [Search] button again to hide the search bar.

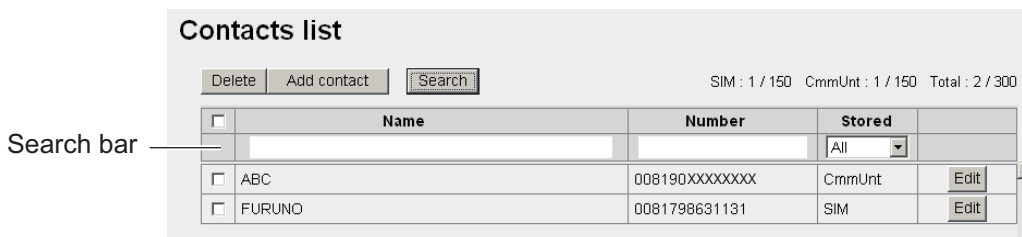

3. To search by name, enter part of the name in the [Name] field. To search by number, enter part of the number in the [Number] field. Contacts that match the entered search name or number appear under the search bar.

**Note:** If [CmmUnt] is selected in the [Stored] list box, only contacts saved on the Communication Unit are displayed. Further, for [SIM], only the contacts stored on a SIM card appear.

### 5.5.3 How to edit contacts

To edit the name or number of a contact, do the following.

1. Click [Contacts] in the menu bar.
2. Select a contact to edit, and click the [Edit] button on the right side of the contact.
3. Edit the name and/or number of the contact. It is also possible to edit the [Stored] field.
4. When finished, click the [Save] button. The message "Completed." appears.
5. Click the [OK] button.

### 5.5.4 How to delete data from contacts

Delete individual, multiple, or all contacts as follows:

1. Click [Contacts] in the menu bar.
2. Put a [✓] in the check-box on the left side of the contact to delete. To select all contacts, put a [✓] in the check-box beside the [Name] title.

**Contacts list**

SIM : 1 / 150 CmmUnit : 1 / 150 Total : 2 / 300

<input type="checkbox"/>	Name	Number	Stored	
<input checked="" type="checkbox"/>	ABC	008190XXXXXXXX	CmmUnit	<input type="button" value="Edit"/>
<input type="checkbox"/>	FURUNO	0081798631131	SIM	<input type="button" value="Edit"/>

Checkbox

3. Click the [Delete] button. The confirmation message "Delete?" appears.
4. Click the [OK] button. The message "Delete completed." appears.
5. Click the [OK] button again to erase the message.

### 5.5.5 How to copy and move contacts data

You can copy or move contacts between the handsets, communication unit and the SIM card. The communication unit acts as a hub for the data transfer. Administrator level (or higher) login is required to access the Contacts list menu and the Copy/Move function.

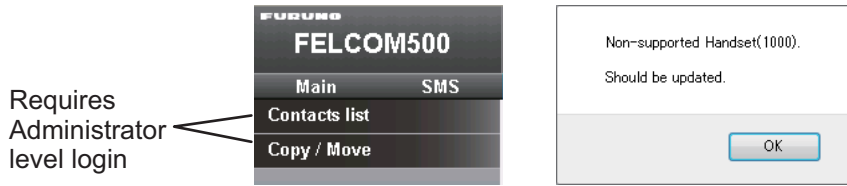

**Note:** The Copy/Move functions are only available on handsets and communication units using version 8.4 software or later. Consult your local dealer to update your software if the above-right error window is displayed when accessing the Copy/Move menu.

The Copy function creates a copy of all the source device contacts data, except short dial numbers, on the destination device.

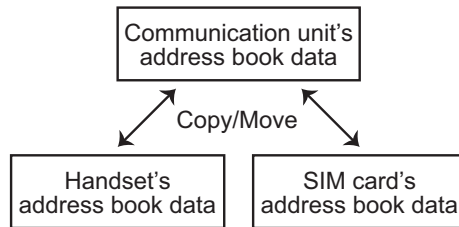

The Move function removes all contact data, except short dial numbers, from the source device and moves it to the destination device. Source data is not deleted until the move is completed.

If the copy/move is interrupted for any reason, an entry in the error log is created.

**Note:** The communication unit cannot store short dial numbers when copying/moving handset contacts to the communication unit. Therefore short dial numbers cannot be transferred between handsets.

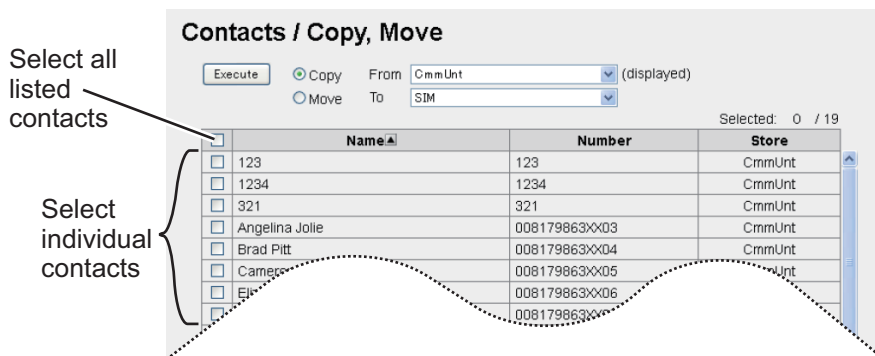

1. Click [Copy/Move] in the [Contacts] sub menu.
2. Select the source using the [From] drop-down box.
3. Select the destination using the [To] drop-down box.
4. Select contacts to be moved or copied, referring to the figure above. You can select one or more individual contacts, or select all contacts.
5. Click [Execute] to begin the copy/move process.



## 5.6 SMS (Short Message Service)

You can create SMS messages from the Web software or the handset. Messages are limited to 160 characters. For the Web software, messages are limited to 70 characters in Japanese, Chinese, French, Russian, Spanish or Arabic due to the Unicode support. Some special characters (pictograms etc.) can not be displayed. For the handset, only Japanese or English is available even if the Unicode support is enabled.

**Note:** Depending on the cellular phone provider, it is not always possible to send or receive messages from Inmarsat terminals. Refer to your cellular phone provider for information.

### 5.6.1 How to enter the SMS password

Enter the password to access the [SMS] menu.

1. Click [SMS] in the menu bar to show the password entry screen.

2. Enter the SMS password. The numerals entered are shown with black circles (●).
3. To disable password entry on future login, put a [✓] in the box at the left side of [Save password] (click the box to add [✓]). To enable the SMS password, see paragraph 5.6.7.
4. Click the [OK] button. If password is correct, the SMS top screen appears.

**Note 1:** If the password is entered incorrectly, the message “Password is invalid” appears. Click [OK] to close the message and correctly re-enter the password.

**Note 2:** From hereafter, the procedures omit password entry.

## 5.6.2 How to send an SMS message

You can send an SMS message to the terminal enabled SMS.

1. Click [SMS] in the menu bar to show the SMS top screen (Inbox).

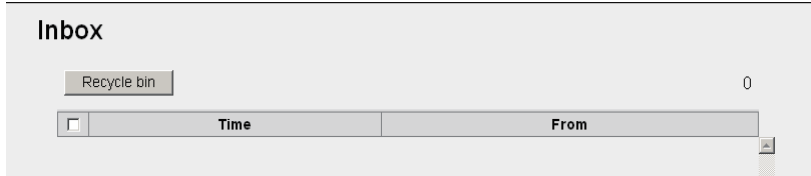

2. Click [Create SMS] in the sub-menu to show the Create SMS screen.

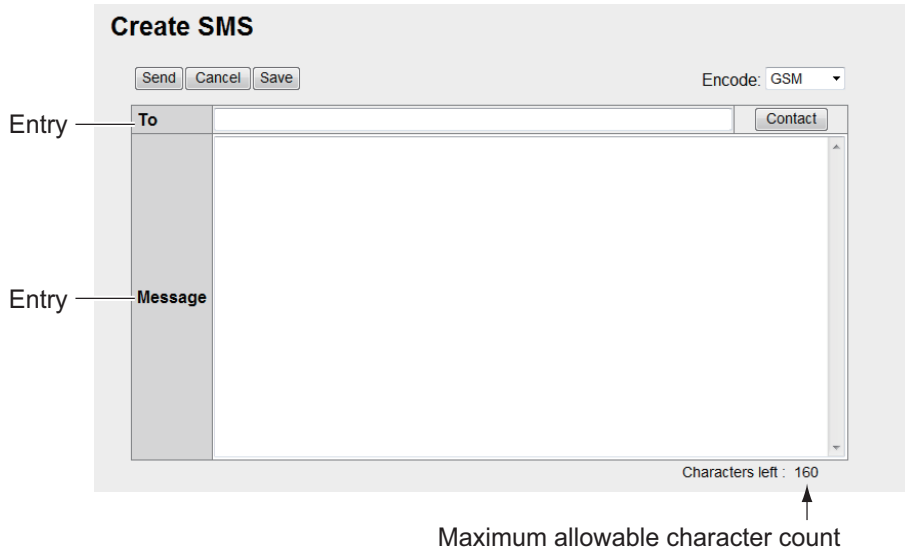

*For [GSM] in the [Encode] box*

3. Use one of the following two methods to select recipient:
  - Get from Contacts:** Click the [Contact] button on the right side of the [To] field to select a recipient from the Contacts list. Select the contact and click the [Select] button.
  - Enter phone number:** Enter the phone number of the recipient in the [To] field (maximum 20 characters, numeric and [+] only)
4. Click the [Encode] box then select [GSM] or [Unicode].
  - [GSM]: Maximum 160 characters (alphanumeric and symbols).
  - [Unicode]: Maximum 70 characters (Japanese or Chinese etc.).
5. Enter the message in the [Message] field.
6. Click the [Send] button to send the message. When send is completed, "Message sent." appears.
  - Note 1:** To save the message without sending, click the **[Save]** button instead of the [Send] button. "Message saved." appears. The message is saved to the Draft box. Click [OK] to return to the SMS top screen.
  - Note 2:** If the message could not be sent, "Message not sent." appears. The message is saved to the Draft box. Click [OK] to return to the SMS top screen.
7. Click the [OK] button.

### 5.6.3 How to review a received message

Received messages are saved to the Inbox.

1. Click [SMS] in the menu bar to show the SMS top screen (Inbox). Unread messages are displayed in bold type.

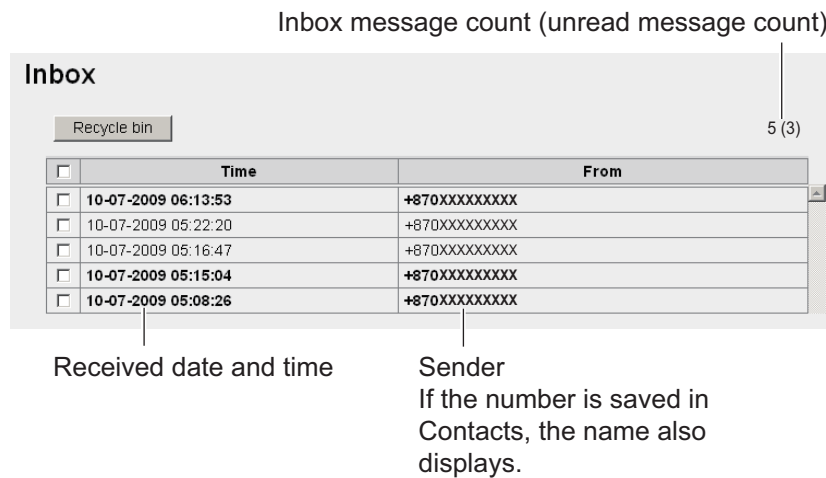

2. Click the received date and time with the mouse. When the mouse pointer moves over the date and time, the date and time are highlighted in blue. Detailed information about the message is displayed.

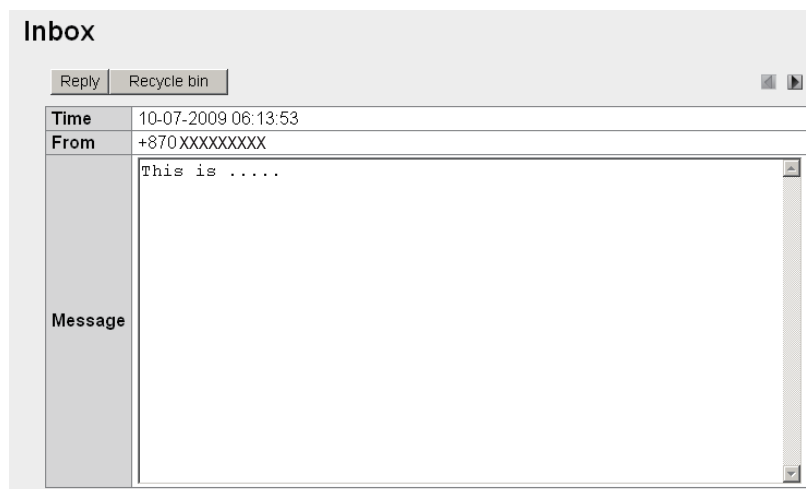

Refer to the table below for operation information:

Operation	Procedure
Reply to sender	<ol style="list-style-type: none"> <li>1) Click the [Reply] button. The Create SMS screen appears with the sender name in the [To] field.</li> <li>2) Click the Encode box then select [GSM] or [Unicode].</li> <li>3) Write the message in the [Message] field.</li> <li>4) Click the [Send] button to send the message.</li> <li>5) Click the [OK] button.</li> </ol>
Send the message to the Recycle Bin.	<ol style="list-style-type: none"> <li>1) Click the [Recycle Bin] button. The confirmation message "Move to Recycle bin?" displays.</li> <li>2) Click the [OK] button.</li> </ol>
View the previous message when there are multiple messages.	Click ◀.
View the next message when there are multiple messages.	Click ▶.

### 5.6.4 Message boxes

There are four message boxes: [Inbox], [Sent], [Draft] and [Recycle bin]. When the amount of messages is more than the maximum, the oldest message in each message box is automatically erased from all boxes.

Box	Message type	Maximum Amount
[Inbox]	Received messages	All boxes: 200 messages total
[Sent]	Sent messages	
[Draft]	Unsent messages	
[Recycle bin]	Messages erased from the other boxes	

#### **How to send messages to the Recycle Bin**

Send a single message, multiple messages or all messages to the Recycle Bin.

1. Click [SMS] in the menu bar.
2. Click the box to erase message from: [Inbox], [Sent], or [Draft].
3. Put a [✓] in the box on the left side of the messages to send to the Recycle Bin. To select all messages, put a [✓] in the box beside the [Time] title.
4. Click the [Recycle bin] button. The confirmation message "Move to Recycle bin?" appears.
5. Click the [OK] button to move the message(s) to the [Recycle bin].

#### **How to sort messages**

Sort messages in the box to list from either newest->oldest or oldest->newest.

1. Click [SMS] in the menu bar.
2. Click the box to arrange: [Inbox], [Sent], [Draft], or [Recycle bin].
3. Click [Time] at the top of the list. The icon ▲ or ▼ appears beside [Time].
4. Click [Time] again to change between ▲ and ▼.  
If ▲: List the messages from oldest to newest.  
If ▼: List the messages from newest to oldest.

**Note:** Click the [From] field (Inbox, Recycle bin) or the [To] field (Sent, Draft) to change the list from descending to ascending order, or vice versa.

### **How to move messages from Recycle Bin to another box**

Move a single message, multiple messages, or all messages in the [Recycle bin] to another box.

1. Click [SMS] in the menu bar.
2. Click the [Recycle bin]. The following screen appears:

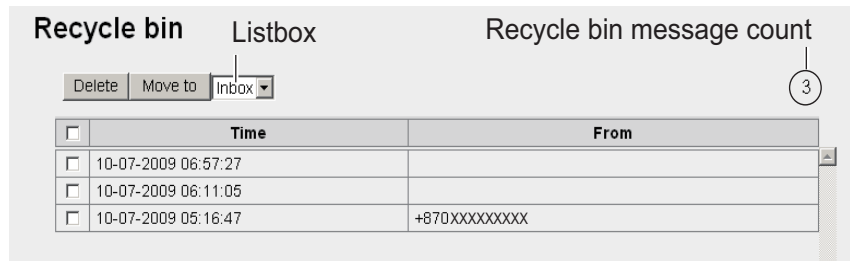

3. Put a [✓] in the box on the left side of the message(s) to move to another box. To select all messages, put a [✓] in the box on the left side of [Time] at the top of the list.
4. Click the list box, and select the destination box ([Inbox], [Sent], or [Draft]).
5. Click the [Move to] button.

**Note:** It is possible to move a message to another box from the [Recycle bin] when the message is open for viewing.

### **How to delete a message from the Recycle Bin**

Delete a single message, multiple messages or all messages from the [Recycle bin].

1. Click [SMS] in the menu bar.
2. Click the [Recycle bin].
3. Put a [✓] in the box on the left side of the message(s) to delete. To select all messages, put a [✓] in the box beside the [Time] title. All messages are selected.
4. Click the [Delete] button. The confirmation message "Delete?" appears.
5. Click the [OK] button. The message "Delete completed" is displayed.
6. Click the [OK] button.

### 5.6.5 How to use the Sent box

Use the Sent message box to edit and resend sent messages.

1. Click [SMS] in the menu bar.
2. Click [Sent] to show the contents of the Sent box.

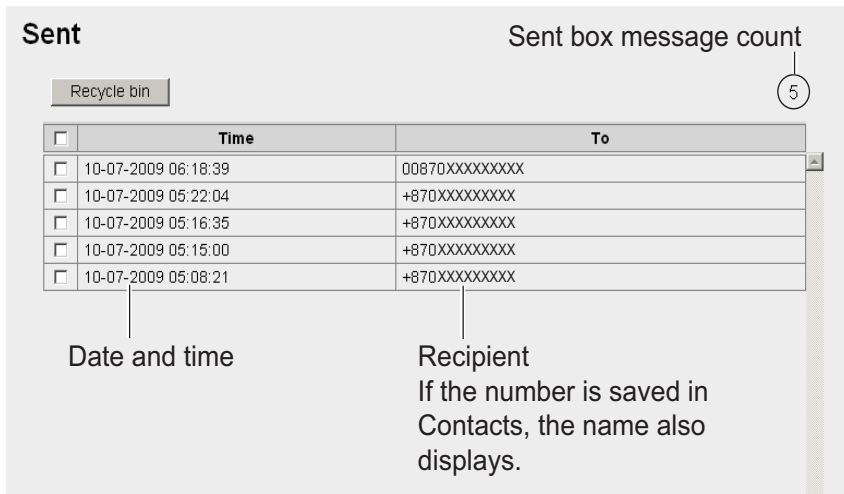

3. Click the sent date and time to select the message to edit/re-send. The message opens.

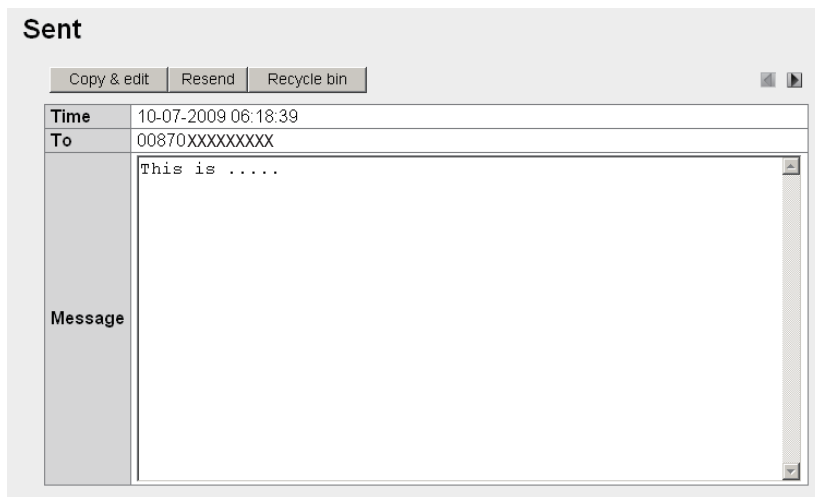

Refer to the following table for operation:

Operation	Procedure
Edit the message and send to the same recipient or another recipient.	<ol style="list-style-type: none"> <li>1) Click [Copy &amp; edit]. The Create SMS screen opens with the original message in the [Message] field.</li> <li>2) Enter another address in the [To] field to send to another recipient.</li> <li>3) Click the [Encode] box then select [GSM] or [Unicode]. <b>Note:</b> When switching from [GSM] to [Unicode] in the [Encode] box, the overflow text than 70 characters are deleted.</li> <li>4) Edit the message in the [Message] field.</li> <li>5) Click the [Send] button to send the message.</li> <li>6) Click the [OK] button.</li> </ol>
Send the message to the same recipient.	<ol style="list-style-type: none"> <li>1) Click the [Resend] button.</li> <li>2) Click the [OK] button.</li> </ol>

## 5.6.6 How to use the Draft box

You can save un-sent messages to the Draft box to edit or send later.

1. Click [SMS] in the menu bar.
2. Click [Draft] to show the contents of the Draft box.

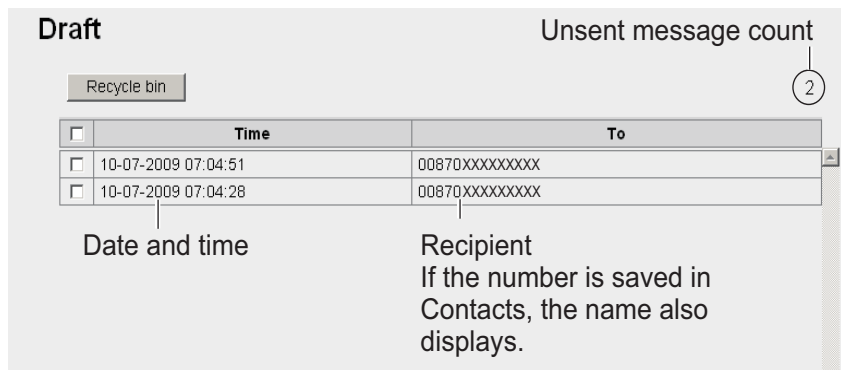

3. Click the date and time to select the message to open.

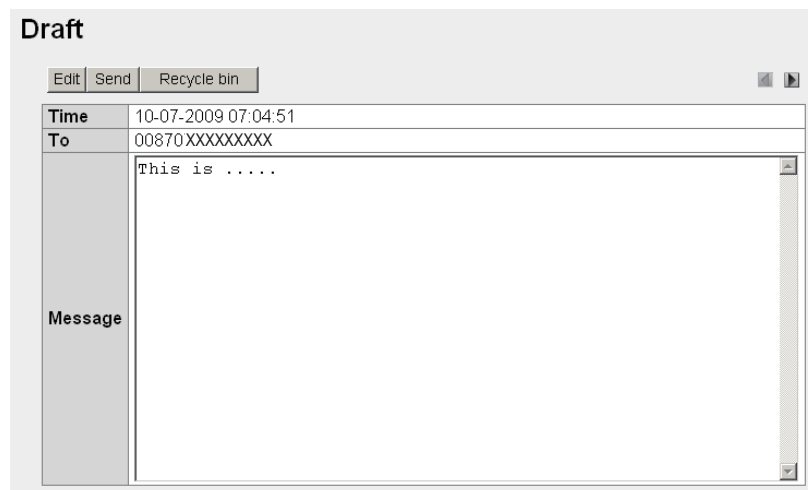

Refer to the following table:

Operation	Procedure
Edit the message and send.	<ol style="list-style-type: none"> <li>1) Click [Edit]. The Create SMS screen opens with the original message in the [Message] field.</li> <li>2) Click the [Encode] box then select [GSM] or [Unicode]. <b>Note:</b> When switching from [GSM] to [Unicode] in the [Encode] box, the overflow text than 70 characters are deleted.</li> <li>3) Edit the message in the [Message] field.</li> <li>4) Click the [Send] button to send the message.</li> <li>5) Click the [OK] button.</li> </ol>
Send the message	<ol style="list-style-type: none"> <li>1) Click the [Send] button.</li> <li>2) Click the [OK] button.</li> </ol>

## 5.6.7 How to set the signature and password

You can set up the SMS signature and password in the SMS Settings screen.

### Signature

Add a signature to all SMS messages automatically as follows:

1. Click [SMS] in the menu bar.
2. Click [SMS settings] to show the [SMS settings] screen.

The screenshot shows the 'SMS settings' screen. At the top right, it says 'Remaining character count'. Below this is a vertical line and the text 'Characters left : 160'. The 'Signature' section has a text input field, a checkbox labeled 'Add signature', and 'Apply' and 'Cancel' buttons. The 'Password' section has two input fields labeled 'Password' and 'Confirm password', a checked checkbox labeled 'Save password', and 'Apply' and 'Cancel' buttons.

3. To automatically add a signature, place a [✓] in the check-box beside [Add signature]. Leave the check-box empty if you don't need a signature. If adding a signature, go to step 4. If not adding a signature go to step 5.
4. Enter a signature in the Signature box.
5. Click the [Apply] button. The message "Setting completed." appears.
6. Click the [OK] button.

### Password

To require a password to access the SMS top screen, do the following.

1. Click [SMS] in the menu bar.
2. Click [SMS settings] in the sub menu area.
3. Erase the [✓] in the [Save password] check-box.
4. Click [Apply]. The message "Setting completed." appears.
5. Click the [OK] button. Hereafter, a password is required to open the SMS menu.



## 5.7 SIM Card Settings

You can update SIM card information and change PIN code.

### How to update SIM card information

Depending on SIM card type, it is necessary to enter a PIN code when power is turned on. It is possible to update the SIM card information.

1. Click [SIM] in the menu bar to show the SIM screen. If no card is input, or if the card is not a Fleetbroadband type, the message "No SIM card / type incorrect." appears.

2. Enter the PIN code in the [PIN code] field. The characters are displayed as black circles (●).
3. Click [Enable] or [Disable].  
[Enable]: When power on, PIN code is required hereafter.  
[Disable]: When power on, PIN code is not required hereafter.
4. Click the [Apply] button. If PIN is enabled in step 3, the message "Setting completed. PIN is prompted when CmmUnt is turned on." is displayed.
5. Click the [OK] button.

### How to change the PIN code

If PIN code is enabled, you can change the PIN code. Be sure to write down the PIN code and do not forget it.

1. Click [SIM] in the menu bar.
2. Enter the current PIN code in the [Current PIN] field.
3. Enter the new PIN code in the [New PIN] field. The PIN code must be between 4 - 8 characters.
4. Re-enter the new PIN code in the [Confirm new PIN] field.
5. Click the [Apply] button.

**Note:** An error occurs if any of the following is done: - Current PIN code is entered incorrectly. "PIN code is invalid." - New PIN code entered at step 3 and 4 is different. "New PIN code is invalid."

6. Click the [OK] button.

## 5.8 Manual Satellite Search

FELCOM 250/500 is set to automatically search and track the closest satellite. It is also possible to manually search for a satellite.

1. Click [Main] in the menu bar.
2. Click [Satellite search]. See the figure below for the service area for FleetBroadband.
  - [ID]: Satellite ID
  - [Satellite]: Satellite name
  - [Position]: Satellite position (longitude)
  - [Primary]: Primary global satellite channel frequency
  - [Alternate]: Alternate global satellite channel frequency

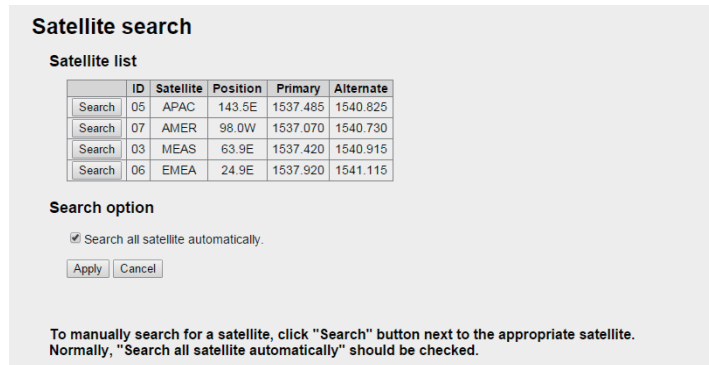

3. Click [Search] to start the Satellite search. The message "Satellite search start." is displayed.
4. Click the [OK] button.
 

**Note:** Put a [✓] in the check-box next to [Search all satellite automatically] to automatically search for a Satellite when tracking is lost.

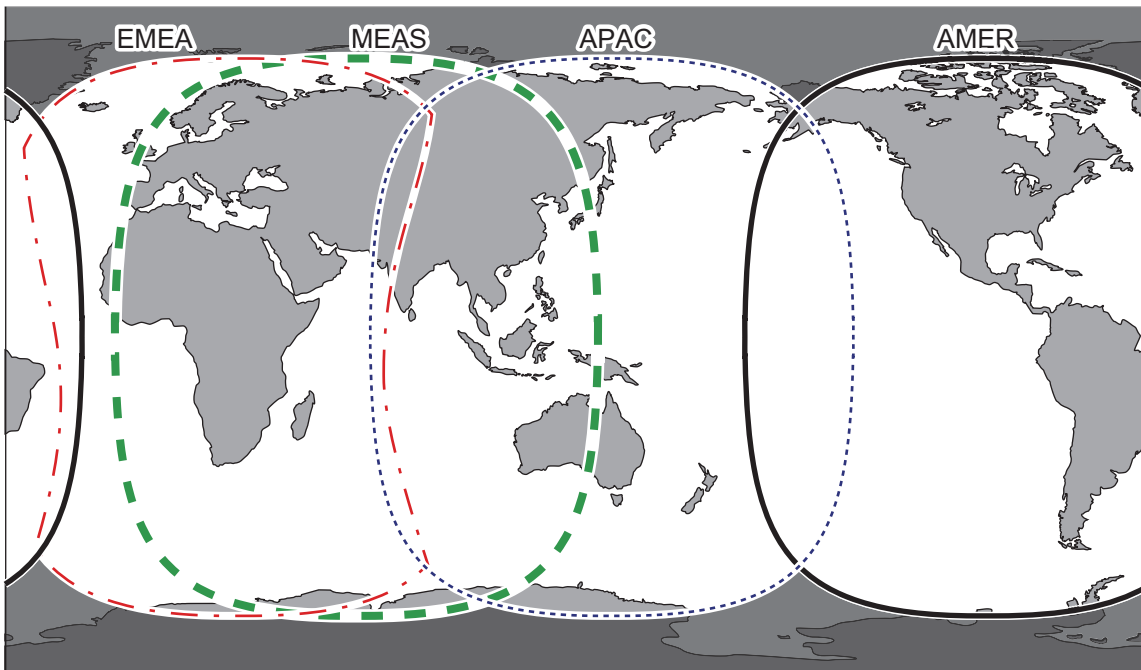

- Name: APAC, ID: 05, Longitude: 143.5E
- Name: EMEA, ID: 06, Longitude: 24.9E
- Name: AMER, ID: 07, Longitude: 97.6W
- Name: MEAS, ID: 03, Longitude: 63.9E

**Note:** This map is supplied as a reference only and is in not a guarantee of service in any of the indicated areas.

## 5.9 Log Displays

You can display four logs: Registration log, Voice call log, Data connection log, and Event log. When the storage capacity of a log is reached, the oldest entries are erased in order.

Log	Capacity for entries	No. of entries displayable
Registration	1000 for each log	100 entries for each log
Voice call		
Data connection		
Event		

**Note 1:** The voice and data communication values shown on the terminal display and within terminal logs are for indicative purposes only. These values should not be utilized for billing or billing comparison purposes.

**Note 2:** The latest 100 entries for any log are shown. To view all the entries of a log, save the log to a CSV file. A log stores up to 1000 entries.

A log can be forwarded to a PC that has the syslog application (see paragraph 6.1.14).

### 5.9.1 How to login to a log with password

Do the following to login to a log with a password.

1. Click the [admin login] button to show the login window.
2. Enter "Log" in the Username box and "01234567" in the Password box. "01234567" is the default password. To change the password, see paragraph 6.1.13.

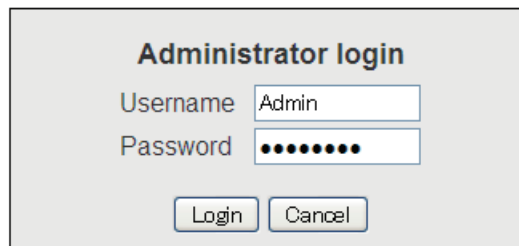

The image shows a dialog box titled "Administrator login". It contains two input fields: "Username" with the text "Admin" and "Password" with seven dots. Below the fields are two buttons: "Login" and "Cancel".

3. Click the [Login] button. "Log" appears in the menu bar. The button name changes from [login] to [logout].
4. To log out, click the [admin logout] button. Log disappears from the menu bar. The button name changes from [logout] to [login].

**Note:** Automatic logout is possible by closing your Web browser.

## 5.9.2 How to view the Registration log

The Registration log displays a list of all satellite registrations. To view the Registration log, do the following:

1. Click [Log] in the menu bar.
2. Click [Registration log]. The following Registration log screen appears:

**Registration log**

Save CSV  Save latest log

①	Date	Sat ID	Voice	Data
	26-Nov-2012 07:12	5	Success	Success
	26-Nov-2012 07:12	5	---	Success
	26-Nov-2012 07:07	5	---	---
	26-Nov-2012 07:07	5	Success	Success
	26-Nov-2012 07:07	5	---	Success
	26-Nov-2012 07:01	5	---	---
	26-Nov-2012 02:32	5	Success	Success
	26-Nov-2012 02:32	5	---	Success
	26-Nov-2012 02:28	5	---	---
	26-Nov-2012 02:27	5	---	Success
	26-Nov-2012 01:26	5	Success	Success
	26-Nov-2012 01:26	5	Success	---
	26-Nov-2012 00:49	5	---	---
	25-Nov-2012 19:16	5	---	---
	25-Nov-2012 19:16	5	---	---
	25-Nov-2012 19:05	5	---	---
	25-Nov-2012 19:05	5	---	---
	25-Nov-2012 18:53	5	---	---

- ① Registration date and time
- ② Registered satellite ID
- ③ Voice communication ("Success" or "---")
- ④ Data communication ("Success" or "---")

3. To save the log as a CSV file, do the following:
  - 1) Specify the way to save the log by clicking the [Save latest log] box and putting a check mark in the box.
    - When "✓" is put in the [Save latest log] box: the logs saved before with "✓" in the [Save latest log] box will not be saved. For example, if you saved 50 logs with "✓" in the [Save latest log] box before and 60 logs are saved currently, only the 10 latest logs will be saved. Make sure to put "✓" in the [Save latest log] box when only the latest logs need to be saved.
    - When "✓" is not put in the [Save latest log] box: all the log will be saved.
  - 2) Click the [Save CSV] button and a dialogue box will appear.
  - 3) Select where to save the file, and click the [Save] button again.

### 5.9.3 How to view the Voice call log

Do the following to view the Voice call log:

1. Click [Log] in the menu bar.
2. Click [Voice call log]. The following Voice call log screen appears:

**Voice call log**

Search Save CSV Save latest log

Date	Service	Dir	Duration	Caller	Connection	Code	
16-Nov-2012 07:26	AMBE	In	00:00:09	---	0081XXXXXXXXXX	--	Detail
16-Nov-2012 07:25	AMBE	In	00:00:16	---	+81XXXXXXXXXX	E7005	Detail
16-Nov-2012 07:24	AMBE	In	00:00:00	---	+81XXXXXXXXXX	--	Detail
16-Nov-2012 07:22	AMBE	In	00:00:36	---	+81XXXXXXXXXX	--	Detail
16-Nov-2012 07:06	AMBE	In	--:--:--	---	+81XXXXXXXXXX	--	Detail
16-Nov-2012 07:04	AMBE	In	00:00:24	---	+81XXXXXXXXXX	--	Detail
16-Nov-2012 07:02	AMBE	Out	00:00:00	Captain	0081XXXXXXXXXX	--	Detail
14-Nov-2012 09:09	AMBE	Out	00:08:43	---	0081XXXXXXXXXX	--	Detail
14-Nov-2012 09:09	AMBE	Out	00:00:00	---	0081XXXXXXXXXX	E7013	Detail

- 1) Communication start date and time
  - 2) Communication service type
  - 3) Incoming / outgoing communication
  - 4) Communication time (hour:min:sec)
  - 5) Sender of access code ("---" appears if access code is not required)
  - 6) Phone number which the call is made to ("No-caller-ID" appears if caller is unknown)
  - 7) Event code ("--" appears)
3. To search the log, do the following:
    - 1) Click the [Search] button to display the Search bar. (Click the [Search] button again to hide the Search bar).

Search bar —

Date	Service	Dir	Duration	Caller	Connection	Code
	All	All				

- 2) To search by date, enter part or all of the date in the [Date] field. To search by phone number, enter part or all of the number in the [Connection] field. Matching search results appear below the Search bar.

**Note:** If [AMBE], [MV]<sup>\*1</sup>, [3.1kHz Audio], [RDI]<sup>\*2</sup> or [UDI]<sup>\*2</sup> is selected in the [Service] list, only the corresponding logs are displayed. Or, if [Out] or [In] in the [Dir] list box is selected, only outgoing messages or incoming messages are displayed, respectively.

\*1: See "IMPORTANT NOTICES" on page i.

\*2: FELCOM500 only

4. To arrange the log in ascending or descending order, do the following:
  - 1) At the top of the log list, click either [Date], [Service], [Dir], [Duration], [Caller], [Connection] or [Code]. ▲ appears beside the selected item.
  - 2) Click the item again to change between ▲ (ascending) or ▼ (descending) order.

- To display the detailed log, click the [Detail] button.  
To return to the Voice call log, click the [Back] button.

**Voice call log / Detail**

<b>Date</b>	26-Dec-2012 09:27:27
<b>Service</b>	AMBE
<b>Direction</b>	Outgoing
<b>Duration</b>	00:00:00
<b>Caller</b>	---
<b>MSISDN</b>	Primary
<b>Connection</b>	+81XXXXXXXXXX
<b>Internal call routing</b>	---
<b>Event code / message</b>	E7017 / No circuit channel available.
<b>Latitude</b>	34°44'24"N
<b>Longitude</b>	135°21'12"E
<b>Signal strength</b>	65.8

Item	Description
Date	Displays the date when the communication starts.
Service	Displays the communication service.
Direction	Displays the communication direction.
Duration	Displays the period for communication.
Caller	Displays the access code of the caller. When the access code is not needed, "- -" appears.
MSISDN*	Displays the number of the Alternative MS-ISDN* for incoming call. "Primary" is displayed in Primary MS-ISDN.
Connection	Displays the number of receiver. When an anonymous call is received, "No-caller-ID" appears.
Internal call routing	Displays the forwarded address with Internal call routing (ICR, see paragraph 6.1.7). <ul style="list-style-type: none"> <li>Extension number (four-digits): Succeeded forwarding.</li> <li>Extension number + X: Failed forwarding then disrupted on shore.</li> </ul>
Event code/ message	Displays the event code and messages. When there is no event code, "- -" appears.
Latitude	Displays the position (Lat) at the time a communication ended.
Longitude	Displays the position (Lon) at the time a communication ended.
Signal strength	Displays the RX signal level (CN0) during communication.

\*: See "IMPORTANT NOTICES" on page i.

- To save the log to a CSV file, click the [Save CSV] button. (See step 3 in paragraph 5.9.2 for details.) The Voice call log additionally records MSISDN, ICR, the Latitude and Longitude, CN0 and Message (only shown when there is an event code).

**Note 1:** You can find the latitude and longitude at the time a call ended and RX signal level by putting the cursor on the date on the Voice call log display. If there is no data (old log, no GPS data) "--'--'", "--'--'" appears.

**Note 2:** You can show the details of an event code by clicking the event code on the Voice call log display. Click the [Back] button to return to Voice call log display.

**Event detail**

<b>Code</b>	E7005
<b>Message</b>	User busy.

## 5.9.4 How to view the Data connection log

To view the Data connection log do the following:

1. Click [Log] in the menu bar.
2. Click [Data connection log] to show the Data connection log screen.

**Data connection log**

Search  Save CSV  Save latest log  Show multi voice log

①	Date	Duration	KBytes	Service	Label	Code	
	11-Jun-2013 04:03	00:10:26	10811	Standard	Session1	--	Detail
	11-Jun-2013 02:29	00:10:06	4824	Standard	Session1	--	Detail
	11-Jun-2013 01:39	00:37:28	37687	Standard	Session1	--	Detail
	11-Jun-2013 00:36	00:02:19	13	Standard	Session1	E8901	Detail
	11-Jun-2013 00:36	00:02:25	8	Standard	Session1	E8901	Detail
	10-Jun-2013 15:00	09:06:55	76	Standard	Session1	E8901	Detail
	10-Jun-2013 15:00	09:07:01	93	Standard	Session1	E8901	Detail
	10-Jun-2013 08:57	06:00:10	6135	Standard	Session1	E8901	Detail
	10-Jun-2013 08:57	06:00:15	80560	Standard	Session1	E8901	Detail
	10-Jun-2013 08:38	00:05:19	16	Standard	Session1	E8901	Detail
	10-Jun-2013 08:38	00:05:24	18	Standard	Session1	E8901	Detail
	10-Jun-2013 08:33	00:01:10	187	Standard	Session1	E8902	Detail

- 1) Date of start of communications
- 2) Communication time (If currently connected, "Connected" appears.)
- 3) Data volume during connection
- 4) Connection service (Standard, 8kbps, 16kbps, 32kbps, 64kbps, 128kbps, 256kbps)
- 5) Group name/session name at time log was saved
- 6) Event code ("--" appears)

"--" appears at 4, 5, 6 above if, when connected to the internet with PPPoE, the entered user name is not registered in the Web software.

3. To search the log, do the following:

- 1) Click the [Search] button to display the Search bar. (Click the [Search] button again to hide the Search bar).

Search Bar —

Date	Duration	KBytes	Service	Label	Code
<input type="text"/>	<input type="text"/>	<input type="text"/>	All	<input type="text"/>	<input type="text"/>

- 2) To search by date, enter part or all of the date in the [Date] field. If you are searching by group name/session name, enter a part of the name in the [Label] field.

Matching search results appear below the Search bar.

**Note:** Select [Standard], [8 kbps], [16 kbps], [32kbps], [64kbps], [128kbps] or [256kbps] (FELCOM 500 only) from the [Service] listbox to view only the selected service.

4. To arrange the log in ascending or descending order, do the following:

- 1) At the top of the log list, click either [Date], [Duration], [KBytes], [Service], [Label], or [Code]. ▲ appears beside the selected item.
- 2) Click the item again to change between ▲ (ascending) or ▼ (descending) order.

- To display the detailed log, click the [Detail] button.  
To return to the Data connection log, click the [Back] button.

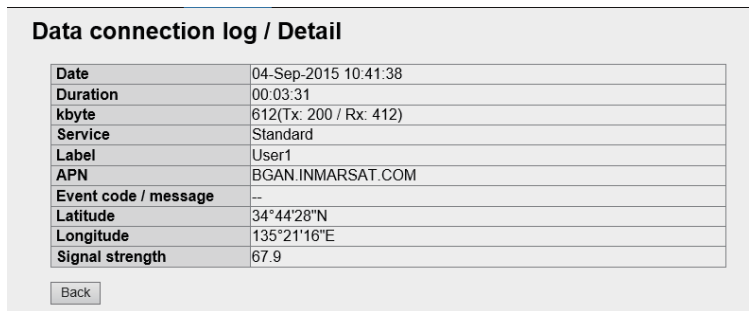

Item	Description
Date	Displays the date when the communication starts.
Duration	Displays the period for communication.
kbyte	Displays the total amount of data during connection. (In the streaming connection, "- -" appears.) <ul style="list-style-type: none"> <li>• TX: Sent data.</li> <li>• RX: Received data.</li> </ul>
Service	Displays the communication service.
Label	Displays Group name/Session name at saving the log.
APN	Access Point Name
Event code/ message	Displays the event code and messages. When no event code, "- -" appears.
Latitude	Displays the position (Lat) at the time a communication ended.
Longitude	Displays the position (Lon) at the time a communication ended.
Signal strength	Displays the RX signal level (CN0) during communication.

- To save the log to a CSV file, click the [Save CSV] button. (See paragraph 5.9.2 for complete information.) The Data connection log additionally records the APN, latitude and longitude, CN0 and Message (only shown when there is an event code).

**Note 1:** You can find the latitude and longitude at the time a call ended and RX signal level by putting the cursor on the date on the Data connection log display. If there is no data (old log, no GPS data) "--°--'--", ---°--'--" appears.

**Note 2:** You can show the details of an event code by clicking the event code on the Data connection log display. Click the [Back] button to return to Data connection log display.



## 5.9.5 How to view the Event log

To view the Event log do the following:

1. Click [Log] in the menu bar.
2. Click [Event log] to show the Event log. Corresponding to the message, the following [Error], [Warning] or [Notice] indicator appears.
  - **Error:** The problem affects the startup of the equipment.
  - **Warning:** The problem limits the functionality of the equipment.
  - **Notice:** Internal event (status). Not an indication of equipment trouble.

**Event log**

Search Save CSV  Save latest log

Date	Block	Message	Code
22-02-12 01:44:05	Modem	Warning: GPS no fix.	E9302
21-02-12 12:10:16	Modem	Notice: Status (PWR ON: 1650233-06.01)	E9901
21-02-12 12:08:07	Modem	Notice: Status (CS registration)	E9998
21-02-12 11:59:43	SIM	Warning: No SIM.	E9502
21-02-12 11:59:42	HUB	Notice: Status (AT+CLCK="SC",2).	E9210
21-02-12 11:59:42	SIM	Notice: Put out during power on.	E9501
21-02-12 11:20:09	Modem	Notice: Status (PWR ON: 1650233-06.01)	E9901
01-02-12 04:59:01	Modem	Warning: GPS no fix.	E9302
01-02-12 04:58:41	HUB	Notice: Status (ver.inf).	E9211
01-02-12 04:58:40	HUB	Notice: Status (ver.inf).	E9211
01-02-12 04:58:40	HUB	Notice: Status (ver.inf).	E9211
01-02-12 04:58:40	HUB	Notice: Status (ver.inf).	E9211
01-02-12 04:58:39	HUB	Notice: Status (ver.inf).	E9211
01-02-12 04:58:40	HUB	Notice: Status (ver.inf).	E9211
01-02-12 03:08:46	Modem	Warning: GPS no fix.	E9302
31-01-12 09:03:43	HUB	Notice: Status (.	E9211
31-01-12 09:03:33	Modem	Error: Internal error (IMEI data).	E9314

- 1) Time of event      2) Location of event      3) Details of event      4) Event code

3. To search the log, do the following:
  - 1) Click the [Search] button to display the Search bar. (Click the [Search] button again to hide the Search bar).

Date	Block	Message	Code
	All		

- 2) To search by date, enter part or all of the date in the [Date] field. To search by event, enter part of the event code in the [Message] field. Matching search results display below the Search bar.
 

**Note:** To display a specific log ([HUB], [SIM], [Handset], [ADE], [Modem]) select the log to display from the [Block] list box.
4. To arrange the log in ascending or descending order, do the following:
  - 1) At the top of the log list, click either [Date], [Block], [Message], or [Code]. ▲ appears beside the selected item.
  - 2) Click the item again to change between ▲ (ascending) or ▼ (descending) order.
5. To save the log to a CSV file, click the [Save CSV] button. (refer to paragraph 5.9.2 for complete information). The Event log additionally records the latitude and longitude (at the time an event was occurred), CN0 (RX signal level).

**Note 1:** You can find the latitude and longitude at the time an event was occurred and RX signal level by putting the cursor on the date on the Event log display. If there is no data (old log, no GPS data) "--°--'--", ---°--'--" appears.

**Note 2:** The details of an event code can be displayed from the Event log by clicking the event code. To return to the Event log, click the [Back] button.

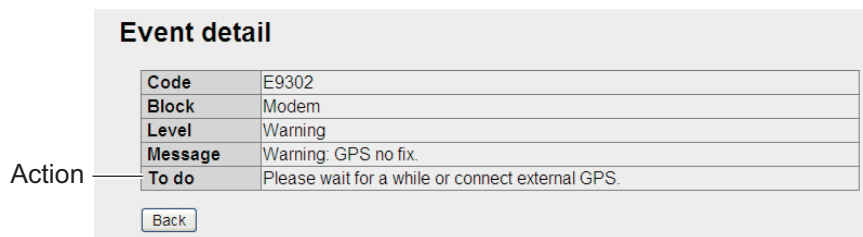

## 5.9.6 How to Download all logs

The logs listed below can be downloaded collectively.

- Version number (Information mentioned in section 7.8)
  - Registration log
  - Voice call log
  - Data connection log
  - Event log
1. Click [Log] on the menu bar.
  2. Click [Get all log].

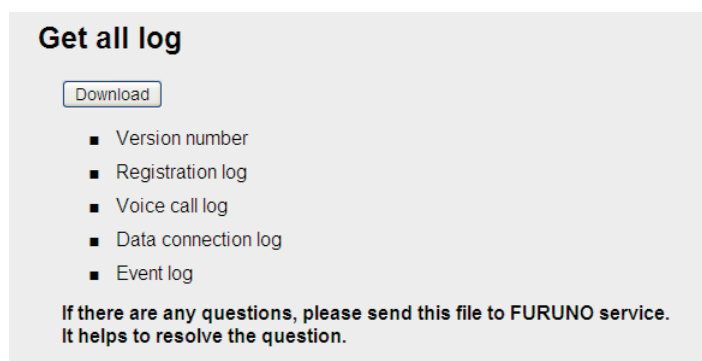

3. Click [Download]. A dialogue box appears.
4. Select where to save the file.  
A .zip file is saved at the location specified.

# 6. WEB FUNCTIONS

---

This chapter covers how to access Communication Unit settings, and connection information. User must login as **Administrator** to access these functions.

**Note:** Communication may not be possible if setting are wrong. Settings should be performed by an experienced administrator. Also, be sure to log out after performing settings. (refer to paragraph 6.1.1)

## 6.1 Communication Unit Settings

In the menu bar, click [Settings] to access Basic, PBX, Network, Password, Log forwarding, Setting saving and loading. For information on [Basic], refer to the Installation Manual.

### 6.1.1 Administrator login

Do as follows to login as Administrator.

1. Click the [admin login] button.
2. Enter "Admin" in the Username box and "01234567" in the Password box. The factory-set Administrator password is 01234567. To change the password, see paragraph 6.1.13. The username cannot be changed.

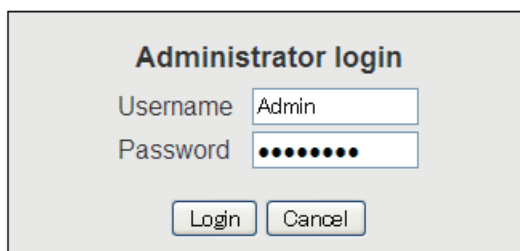

The image shows a dialog box titled "Administrator login". It contains two input fields: "Username" with the text "Admin" and "Password" with seven dots. Below the fields are two buttons: "Login" and "Cancel".

**Note:** If you forgot the Administrator password, consult your dealer for advice. This operation requires restoration of the default settings.

3. Click the [Login] button. Log, Settings, Device, Selftest appear in the menu bar, and [login] is replaced with [logout].
4. To logout after completing all settings, click the [admin logout] button. Log, Settings, Device, Selftest disappear from the menu bar, and [logout] is replaced with [login].

**Note:** The system automatically logs you out when there is no key operation in 15 minutes.

### 6.1.2 How to display the Information screen

You can view information of GPS, Analog ports, Incoming Indicator, and Serial port in the [Basic] submenu, LAN and PPPoE in the [Network Settings] submenu.

1. Click [Settings] in the menu bar. The Settings sub menu is displayed on the left hand side.
2. When the Information screen is not displayed, click [Information] in the sub menu to display the Information screen.

**Information**

<b>Basic / GPS(NMEA port)</b>		<b>Basic / Serial port</b>	
Baud rate	4800bps	Baud rate	115200bps
<b>Basic / Analog ports</b>		Parity	None
Port1	No connection	Flow control	Hardware
Port2	No connection	<b>Network settings / LAN</b>	
Port3	No connection	MAC address	00:D0:1D:08:C7:48
Port4	No connection	IP address	192.168.1.1
<b>Basic / Incoming indicator</b>		Subnet mask	255.255.255.0
Ringing pattern	Different	DHCP	Use
Enabled service	Voice,FAX	<b>Network settings / PPPoE</b>	
		Server address	192.168.254.1

### 6.1.3 Extension number settings

#### How to register extension numbers

If you install a new handset or analog telephone, register the extension line number (Handset: maximum 26 numbers, Analog phone: maximum 4 numbers).

1. Click [Settings] in the menu bar.
2. Click [PBX settings].
3. Click [Extension], and the following screen appears.

No. of entries made / Max. no. of entries  
 Analog ports: telephone  
 IP Phone: handset  
 Total: telephone + handset

**PBX settings / Extension**

Analog ports : 1 / 4    IP Phone : 3 / 26    Total : 4 / 30

<input type="checkbox"/>	Num	Reg.	Note	V1	V2	F1	F2	Call limit	Access	Filter	<input type="button" value="Edit"/>
<input type="checkbox"/>	2001	●		✓				None			<input type="button" value="Edit"/>
<input type="checkbox"/>	1000	●	Captain	✓	✓			None			<input type="button" value="Edit"/>
<input type="checkbox"/>	2002			✓				None	✓		<input type="button" value="Edit"/>
<input type="checkbox"/>	1503	●		✓	✓			Outside		✓	<input type="button" value="Edit"/>

SIP Server Certification  
 (If no ●, terminal cannot be used)

4. Click the [Add extension] button. The screen shown below appears. The number that is shown in the [Number] box is the youngest empty unused extension num-

ber. To use that number, go to step 6. To change the extension number, go to step 5.

5. Change the extension number (1000 - 9999) in the [Number] box.
6. Enter the extension number password in the [Password] box. A maximum of eight characters (capital letters only) can be entered.  
**Note:** Be careful not to lose the extension number password. Write it down. This password is necessary for setting the SIP password.
7. Enter a name for the extension number in the [Note] box. A maximum of 50 characters can be used (use an easy-to-remember name, like the location of the extension).
8. Set the parameters for outside lines at the [Voice ring] box. Check “1st” to ring that terminal first. For no ring, uncheck “1st”. Check “2nd” to ring 2nd terminal if there is no pick up for the specified period at the terminal checked as 1st. See paragraph 6.1.6 for how to set ring duration time in the [2nd ring timer] menu on the [PBX settings/General settings] screen.
9. Set the parameters for facsimile at the [Fax ring] box. The setting procedure is the same as that for [Voice ring].
10. Select the line for which to limit call time, in the [Call limit] box. Choose from among No limit, Extension only, Incoming only, Outside only.
11. “Access code”, if checked, requires input of access code to access an outside line. The Caller ID is recorded to the Voice Call log to identify the person accessing the outside line. Refer to page 6-6 regarding the procedures to register the access code.  
**Note:** Access code requirement cannot be set in the following cases:
  - When “Extension only” or “Incoming only” is selected in the Call limit box (step 10).
  - When “Call filter for outside call” below is enabled.
12. At “Call filter for outside call”, set the restrictions for outside calling. Check “Enabled” to activate the restrictions, set in the boxes. See the table below for example restrictions. A maximum of five restrictions with 20 characters can be set.

	Usage	Input Example	Remarks
1	Register telephone number of shore office.	+81798631131#	Forbid outside calls to other than the phone number registered here.
2	Register only country number (Japan for example).	+81	Permit calls only to Japan.
3	Register the number exclusive use of pre-paid card.	66#	Forbid outside calls other than those made with a pre-paid card.

**Note:** Call filter for outside call cannot be set in the following cases:

- When “Extension only“ or “Incoming only“ is selected in the Call limit box (step 10).
- “Required” is checked at the “Access code box” (step 11).

13. Click the [Add] button, and the message "Completed" appears.

**Note:** If the extension number is already registered, the error message "This number has already been registered." appears. ([Number] of [Analog ports] in [Basic settings] and [Number] of [Group] in [PBX settings] are included.) Input the extension number using a number not previously registered.

14. Click the [OK] button to erase the message.

### **How to edit extension numbers**

You can edit the extension number, password, name and Call limit etc.

1. Display the Extension screen.
2. Click the [Edit] button at the right side of the extension to edit.
3. Edit extension number, extension number password (SIP password). If the extension number selected at step 2 is from an analog port, the [Password] box does not appear.
4. Click the [Save] button.
5. Click the [OK] button to erase the message.
6. If you edit the extension number, or extension number password (SIP password) in step 3, set the same value in the [Client set.] menu of the handset (refer to paragraph 3.5.3).

### **How to delete extension numbers**

You can delete a single extension number or all extension numbers.

1. Display the Extension screen.
2. Put a check [✓] in the check-box at the left side of the extensions to delete. (Check as many numbers as desired.) To delete all extension numbers, put a check in the [Num] check-box at the top of the screen. This puts a checkmark on all numbers.
3. Click the [Delete] button.
4. Click the [OK] button.
5. Click the [OK] button again.

## 6.1.4 Group settings

Register numbers to a group and make a group call (internal only). For example, add numbers 1001-1010 to group 9000, and all numbers from 1001-1010 can be called at the same time. The first recipient to answer receives the call, and the other numbers stop ringing.

### How to register a group

A maximum of 50 groups can be registered. Only members registered on [Extension] in [PBX Settings] can be registered.

1. Click [Settings] in the menu bar.
2. Click [PBX settings].
3. Click [Group]. The following Group screen appears.

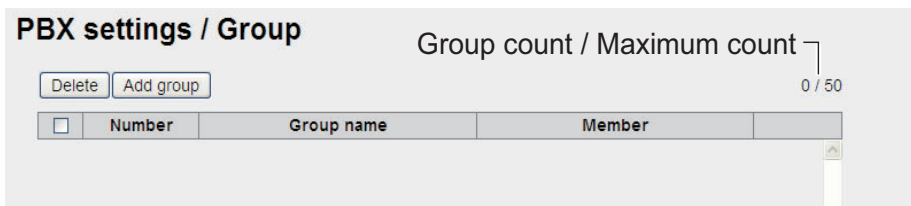

4. Click [Add group]. The following New Registry screen appears. [Number] field displays the lowest 9000 number not in use. If using this number, go to step 6. If entering a new number, go to step 5.

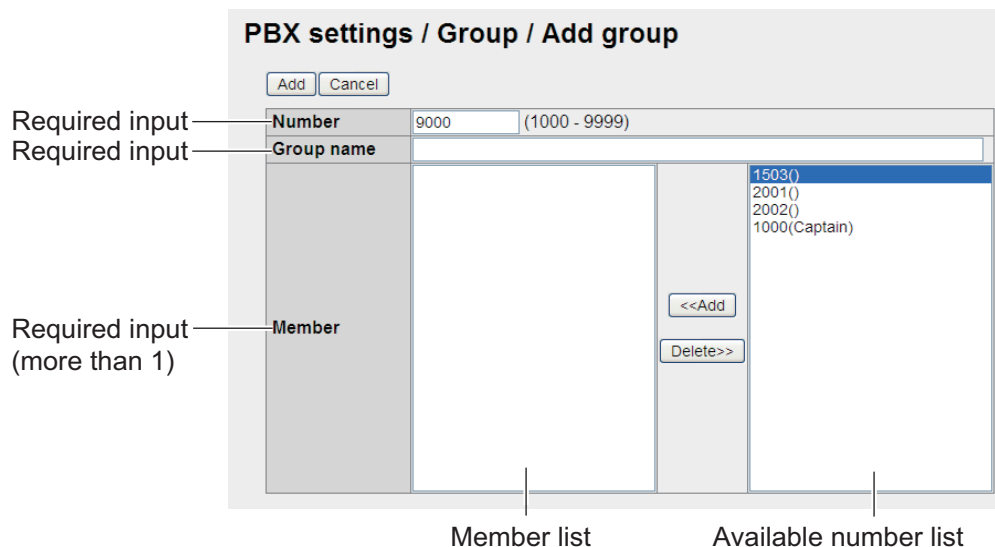

5. In the [Number] field, enter the group number (1000 - 9999).
6. Enter a name for the group in the [Group name] field (max. 50 characters).
7. Add members to the group as follows:
  - 1) Click desired number in the available numbers list.
  - 2) Click the [<<Add] button to add the selected number to the member list.
 

**Note:** If you added a wrong number, select the number in the member list and click [Delete >>] to erase the number from list.
  - 3) Repeat steps 1 and 2 to add more members to group.
8. Click the [Add] button. The message "Completed." appears.
 

**Note:** The following messages are displayed when you try to register a number that has already been registered:

## 6. WEB FUNCTIONS

- "This number has already been registered": The number already exists.
9. Click the [OK] button. The Group screen is displayed with the new group.

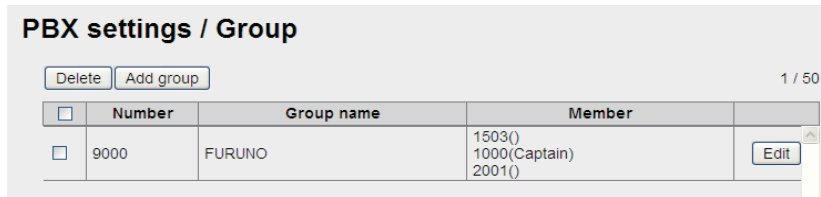

### How to edit a group

- 1) Display the Group screen.
- 2) Select the group number to edit, and click the [Edit] button.
- 3) Edit the group number, name or members.
- 4) Click the [Save] button.
- 5) Click the [OK] button.

### How to delete a group

- 1) Display the Group screen.
- 2) Put a [✓] in the check-box beside the group number to delete. To delete all group numbers, put a [✓] in the check-box beside [Number] to select all.
- 3) Click the [Delete] button.
- 4) Click [OK].
- 5) Click [OK] again to close the message window.

## 6.1.5 Access code settings

When making an outside call from a terminal of which the [Access] box of [Extension] of [PBX settings] is checked, input of "access code" and "\*" before the phone number of the party to call is required.

### How to register access code

Register the access code as follows:

1. Click [Settings] in the menu bar.
2. Click [PBX settings].
3. Click [Access code] to show the Access code register screen.

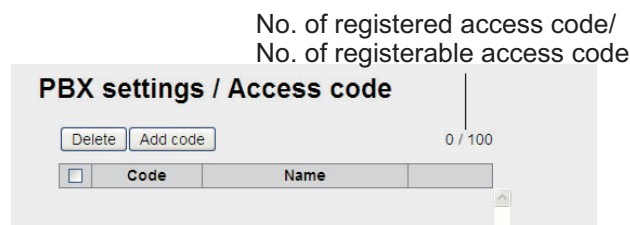



- Click the [Add code] button.

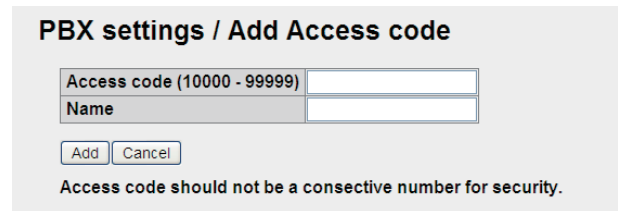

**PBX settings / Add Access code**

Access code (10000 - 99999)

Name

Access code should not be a consecutive number for security.

- Enter the access code in the [Access code] field (10000 - 99999).
- Enter a caller name in the [Name] field (10 characters at the maximum). Only alphabet characters, “\_” and “-” can be entered. The name entered in this field appears in the “Caller” box of the Voice call log.
- Click the [Add] button.  
The message “Setting Completed” appears.  
**Note:** An error message appears in the following cases.
  - When the access code entered in step 5 is already registered, the message “This code has already been registered” appears.
  - When the name entered in step 6 is already registered, the message “This name has already been registered” appears.
- Click the [OK] button to erase the message.

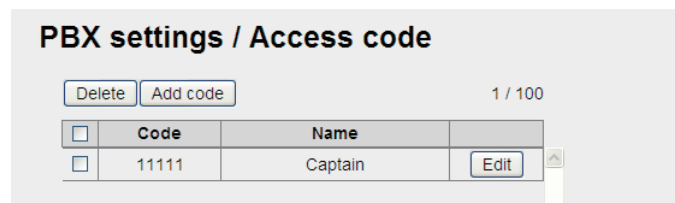

**PBX settings / Access code**

1 / 100

<input type="checkbox"/>	Code	Name	
<input type="checkbox"/>	11111	Captain	<input type="button" value="Edit"/>

**Note:** [Code] and [Name] can be displayed in ascending or descending order by clicking [Code] or [Name] on the top of the list.

### **How to edit access code**

To edit the registered access code or name, do the following.

- Display access code register screen.
- Click the [Edit] button on the right side of the access code to be edited.
- Edit the access code and/or name.
- Click the [Save] button.
- Click the [OK] button to erase the message.

### **How to delete access code**

Delete a single access code, multiple, or all access codes.

- Display the access code register screen.
- Put a [✓] in the check-box on the left side of the access code to delete (multiple access codes can be selected). To select all access code, put a [✓] in the check-box beside the [Code] title.
- Click the [Delete] button.
- Click the [OK] button.
- Click the [OK] button again to erase the message.

## 6.1.6 PBX settings

### How to set the ring duration time

Set the ring duration time of the terminal checked (✓) in the [V1] (or [F1]) box of the PBX settings/ Extension screen. (Not available for the multi voice and the extension.)

1. Click [Settings] in the menu bar.
2. Click [PBX settings].
3. Click [General settings] to show the [PBX settings / General settings] window.

4. Enter the ring duration time (0-99 seconds) in the [Voice] or [Fax] box. When the ring duration time has passed with no response of the terminal checked (✓) in the [V1] (or [F1]) box of the PBX settings/ Extension screen, the terminal checked in the [V2] (or [F2]) rings. If the ring duration time is "0", the terminal checked in the [V2] (or [F2]) does not ring.

**Note:** The ring duration time may change depends on the Inmarsat settings.

5. Click the [Apply] button. The message "Setting Completed." appears.
6. Click the [OK] button to erase the message.

### How to set the automatic timeout function

The automatic timeout function automatically disconnects a voice call (with the exception of emergency call type 505) when the receiver is left unhooked for the specified number of minutes. This feature is useful for prevent unwanted charges because the phone is left off hook.

1. Click [Settings] in the menu bar.
2. Click [PBX settings].
3. Click [General setting] to show the setting window.
4. To enable the timeout feature, check [Enabled]. To disable this feature, clear the check.
5. Enter the timeout (1-99 minutes) in the [Timeout] box.
6. Click the [Apply] button. The message "Setting Completed." appears.
7. Click the [OK] button to erase the message. The communication which has passed specified time at step 5 is disconnected automatically.

## 6.1.7 How to set internal call routing

When a voice call (only 4kbps AMBE+2) is received, the call can be transferred to an internal phone automatically. Follow the procedures to set up the internal call routing.

1. Click [Settings] in the menu bar.
2. Click [PBX settings].
3. Click [Advanced settings].
4. Click [Internal call routing].

**PBX settings / Advanced settings / Internal call routing**

Internal call routing [?](#)

Enable / Disable	<input checked="" type="checkbox"/> Enabled
Guidance language	English ▾
Timeout (10-99)	30 second(s)

5. To enable the internal call routing function, put a checkmark in the Enable/Disable box. With no checkmark this function is deactivated, and a call is routed according to the setting of [PBX settings / Extension] in paragraph 6.1.3.
6. Select a guidance language; English or Japanese.
7. Set a timeout time between 10 seconds to 99 seconds.
8. Click the [Apply] button to activate the internal call routing. The message "Setting Completed." appears.
9. Click the [OK] button to erase the message.

When a voice call is received, the FELCOM 250/500 plays guidance to the calling party. Then, the calling party inputs an extension number. The call is then transferred to that number. If nobody answers the transferred call within the timeout time, the call is transferred again to phones according to the setting of [PBX settings / Extension]

### ► Operation at calling side in the automatic transfer function

- 1) Call this vessel (AMBE+2). You are requested to dial extension number.
- 2) Dial extension number (4 digits). The extension number is called.
- 3) When the party answers, pick up the receiver.
- 4) Hang up the receiver after completing the call.

### 6.1.8 LAN settings

The LAN Settings must be performed by **the network manager**.

#### How to set the LAN IP address

Click [Settings] in the menu bar, the [Network settings], [LAN] and [IP address] in the sub-menu. The following screen appears.

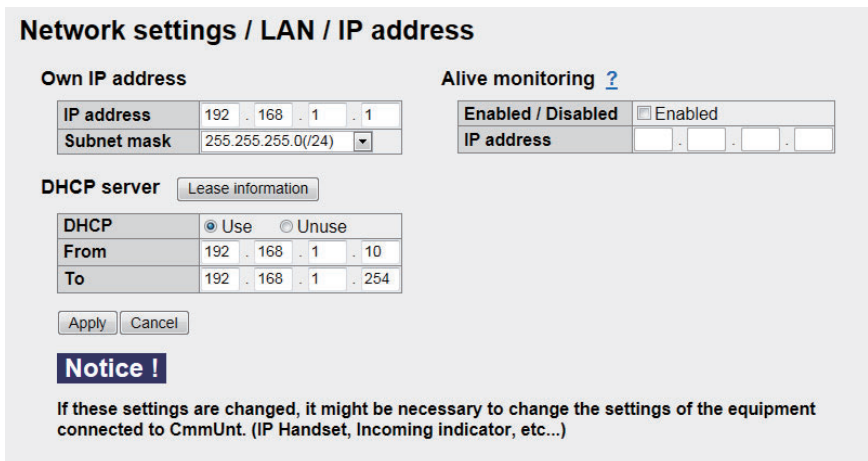

Item	Description
<b>Own IP address</b>	
IP address	Enter the LAN IP Address (IPv4 Address). Default: [192.168.1.1.]
Subnet mask	Select the LAN Subnet mask.
<b>Alive monitoring</b>	
Enabled/Disabled	Check [✓] Enabled if WAN communication is available. (Default: Disabled) When enabled, the terminal sent an ICMP request can respond. (This will indicate if the internet is available.)
IP address	Enter the IPv4 address of the server according to the ICMP request. (Default: 192.168.1.2)
<b>DHCP server</b>	
Lease information button	Go to the DCHP lease information screen.
DHCP	Use: Use DHCP Server in the communication unit. Unuse: Do not use DHCP Server.
From	Enter assigned commencement IP address (IPv4 address). Factory setting is [192.168.1.10].
To	Enter assigned last IP address (IPv4 address). Factory setting is [192.168.1.254].
Apply button	Click to apply settings. The screen shows "The Comm. Unit will restart automatically to apply this setting. Press OK to continue." → [OK] button → "Completed. Please wait a moment for restarting." displays → press the [OK] button to close message → Equipment restarts.
Cancel button	Restore previous settings.

## DHCP lease information screen

No. of entries made / No. of entries possible

**Network settings / LAN / IP address / DHCP lease**

Delete Add lease Back Lease manually : 1 / 100

<input type="checkbox"/>	IP address	MAC address	Status	
<input type="checkbox"/>	192.168.1.241	00:d0:1d:03:41:66	Automatic	Change manual
<input type="checkbox"/>	192.168.1.206	00:13:72:81:fe:bf	Automatic	Change manual
<input type="checkbox"/>	192.168.1.129	00:d0:1d:03:41:67	Automatic	Change manual
<input type="checkbox"/>	192.168.1.220	00:1c:23:3e:1e:4b	Manual	Edit

Item	Description
Delete button	Delete the item which has a checkmark.
Add lease button	Enter new lease information. The screen for entry of new lease information appears.
Back button	Return to IP address entry screen.
IP address	Assigned IP address is shown.
MAC address	MAC address of the network device for the assigned IP address is shown.
Status	Automatic assignment, Manual assignment
Change manual button	Change from automatically assigned to manually assigned (the maximum no. for manual assignment is 100).
Edit button	Change lease information. (Appears in manual assignment only.) The screen for changing lease information appears.

Entry screen/Edit screen

**Network settings / LAN / IP address / DHCP / Add lease**

MAC address  -  -  -  -  -

IP address  .  .  .

Add Cancel

Entry screen

**Network settings / LAN / IP address / DHCP / Edit lease**

MAC address 00  - 1c  - 23  - 3e  - 1e  - 4b

IP address 192  . 168  . 1  . 220

Save Cancel

Edit screen

Item	Description
MAC address	Enter MAC address of device to be registered. Available characters: 2 characters x 6 bytes.
IP address	Enter or change the manually assigned IP address (IPv4 address).
Add button	Register information entered. Return to DHCP lease information screen.
Save button	Save information entered. Return to DHCP lease information screen.
Cancel button	Return to DHCP lease information screen.

**Routing information settings**

Click [Settings] in the menu bar, [Network settings], [LAN] and [Routing] in the sub-menu. The following screen appears.

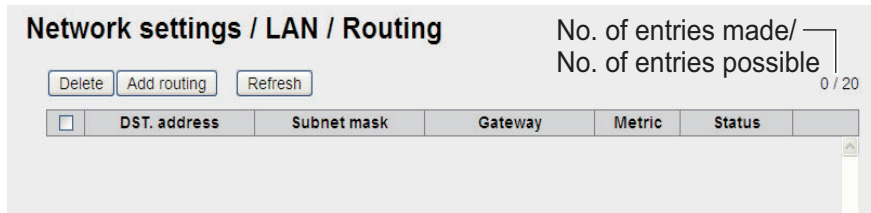

Item	Description
Delete button	Delete item having a checkmark [✓]. Items which the [Status] is [Dynamic] cannot be deleted.
Add routing button	Enter new routing information. (A maximum of 20 can be registered.) The screen for entry of routing information appears.
Refresh button	Update information.
DST. address	Display destination address.
Subnet mask	Display subnet mask.
Gateway	Display gateway.
Metric	Display metric information.
Status	Display status information. Static, Dynamic.
Edit button	Shown when [Status] is [Static]. Change routing information. The information screen for change routing appears.

Entry screen/Edit screen

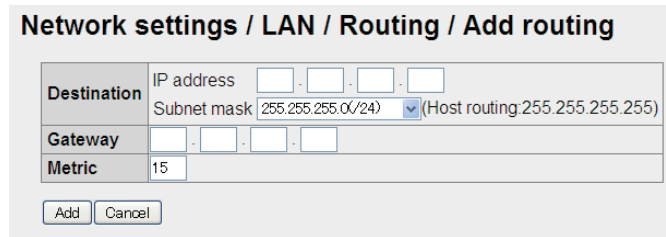

Entry screen

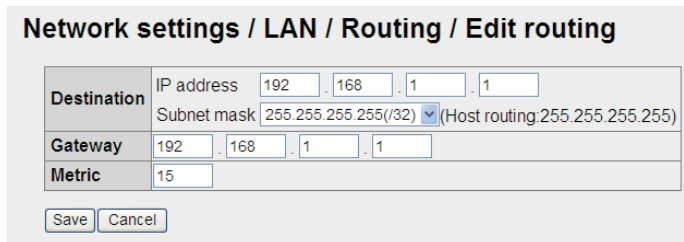

Edit screen

Item	Description
Destination	Destination address. <ul style="list-style-type: none"> <li>• IP address: Entry and change of destination IP address (IPv4).</li> <li>• Subnet mask: Select LAN-side subnet mask. 255.255.255.255 is for host routing.</li> </ul>
Gateway	Enter and change default gateway (IPv4).
Metric	Enter and change metric (numeric input: 01 - 15). Input available: 2 numeric characters.

Item	Description
Add button	Register information entered. Return to routing information setting screen.
Save button	Save information entered. Return to routing information setting screen.
Cancel button	Return to routing information setting screen.

### RIP settings

Click [Settings], [Network settings], [LAN] and [RIP] in the menu bar. The following screen appears.

Item	Description
Tx RIP to LAN	Select RIP transmission to LAN. (None, RIP1&RIP2, RIP1, RIP2.) Default setting: None
Rx RIP from LAN	Select RIP reception from LAN. (None, RIP1&RIP2, RIP1, RIP2.) Default setting: None
Apply button	Click to apply settings.
Cancel button	Restore previous settings.

### Virtual router settings

Click [Settings], [Network settings], [LAN] and [VRRP] in the menu bar. The following screen appears.

Item	Description
Enabled/Disabled	Enabled: VRRP valid, Disabled: VRRP invalid (default). The settings mentioned below cannot be changed when [Disabled] is active.
Name	Enter name of virtual router. (alphanumeric input, a maximum of 50 characters)
IP address	Enter the IP address (IPv4) of the virtual router.
VRRP ID (1-255)	Enter VRRP ID (numeric input, 1 - 255).
VRRP Tx interval	Enter VRRP transmitting interval (numeric input, 1 - 99).
Priority (1 - 254)	Enter priority (numeric input, 1 - 254).
Preempt mode	Enable or disable the preempt mode. [✓] indicates enabled. Default: enabled
Status	Show status (Master, Backup, Error enabled/disabled).
Apply button	Click to apply settings.
Cancel button	Restore previous settings.

### 6.1.9 WAN settings

The network equipment (PC, etc.) connected to the FELCOM can be divided into multiple groups to get independent data connection for each group. For example, you can have a group for office use and a group for private use. In this way crew members can pay for their own personal communication charges, making it unnecessary to limit communications. The Network Administrator is responsible for the entry of WAN-related settings.

#### WAN group setting

Click [Settings] in the menu bar, then [Network settings], [WAN] and [Group settings] in the sub-menu to the WAN group setting screen. The connection list has one group (group name: Default) registered to the list.

No. of registered groups/Total no. of groups available

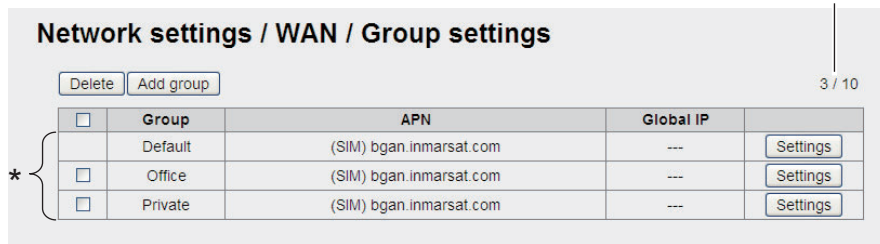

\*: Connection list

Item	Description
Delete button	Delete the item having a checkmark [✓]. <ul style="list-style-type: none"> <li>• [Default] at the top of the connection list, cannot be deleted.</li> <li>• A session cannot be deleted during PS*. *PS: Packet Switching</li> </ul>
Add group button	Create a new WAN group. Up to ten groups can be created. The creation screen appears.
Group	Display group names.
APN	Display connection destinations. (If connection destination is registered in the SIM card: "(SIM) connection destination" appears.)
Global IP	<ul style="list-style-type: none"> <li>• Data connection in use: Global IP address is shown.</li> <li>• Not connected: "----" appears.</li> </ul>
Setting button	Show the group setting screen. The group setting screen has nine types of setting screens. (Group can be registered to each screen.)

#### Entry screen

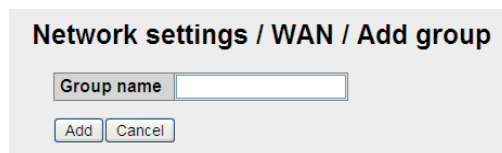

Item	Description
Group name	Enter group name.
Add button	Register entered information. Control returns to the WAN group setting screen.
Cancel button	Return to the WAN group setting screen.



## Group setting screen (basic)

Click [Basic] on the Group setting screen to show the basic setting screen. This screen is where you make a connection list.

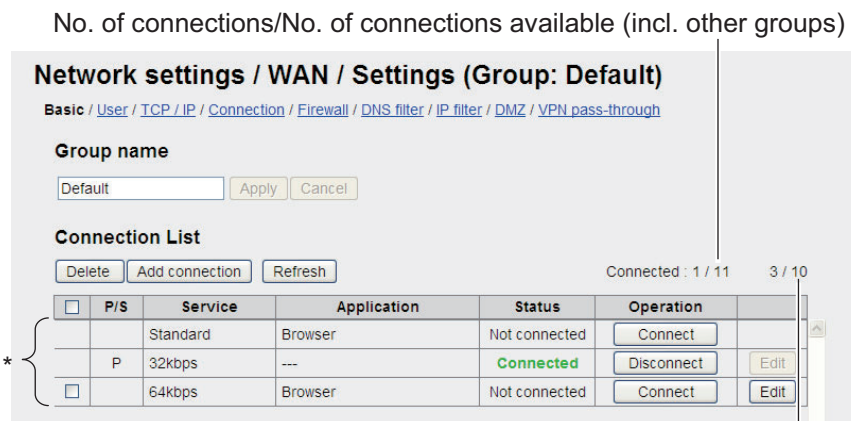

\*: Connection list      No. of registrations/No of registrations available

Item	Description
<b>Group name</b>	
Group name	Display, change Group name.
Apply button	Confirm changes to group. (Not available during PS.)
Cancel button	Cancel changes made on the above screen. (Not available during data connection.)
<b>Connection list</b>	
Delete button	Delete the item having a checkmark [✓]. <ul style="list-style-type: none"> <li>Cannot delete item (Standard/Browser) at top of connection list.</li> <li>During PS, any item having Status as Connected cannot be deleted. (No check-box)</li> </ul>
Add connection button	Create connection list (10 connections can be registered.) The create screen appears.
Refresh button	Refresh the screen.
P/S	<ul style="list-style-type: none"> <li>P: First data connection for each group is shown.</li> <li>S: Second and subsequent data connections for each group are shown.</li> </ul>
Service	Show service available.
Application	Show application available. (Effective for second or after PS.)
Status	Display connection status. Connected, or Not connected is shown.
Operation	<ul style="list-style-type: none"> <li>Disconnect button: Disconnect connection.</li> <li>Connect button: Establish connection.</li> </ul> <p><b>Note:</b> Disconnecting a service that is prefixed with a P mark disconnects all services currently connected.</p>
Edit button	Edit the connection list. (Not available during PS.) Control goes to the Edit screen.

Entry screen/Edit screen

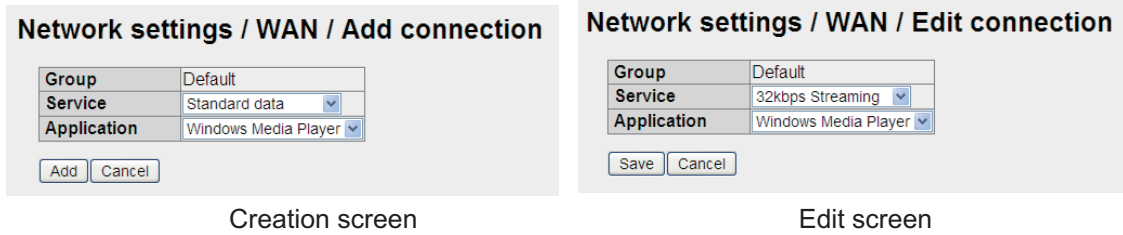

Creation screen

Edit screen

Item	Description
Group	Display group name.
Service	Select service to use. (Standard data, 8kbps Streaming, 16kbps Streaming, 32kbps Streaming, 64kbps Streaming, 128kbps Streaming, 256kbps Streaming*) The topmost item on the connection list (Standard) cannot be changed. * FELCOM 500 only
Application	Effective for second or after PS. Select application to use (Windows Media Player, Quick Time, Real Player, FTP, Browser). <b>Note:</b> The topmost item (Browser) on the connection list cannot be changed.
Add button	Register entered information. Control returns to the group setting screen.
Save button	Save entered information. Control returns to the group setting screen.
Cancel button	Return to the group setting screen.

Group setting screen (User)

Click [User] on the group setting screen to show the User setting screen. Enter IP address of handset and PC to enable data connection. If no IP address is entered, “D: No permission” appears on the standby display of the handset and “Data connection No permission” appears on the main display of the web software.

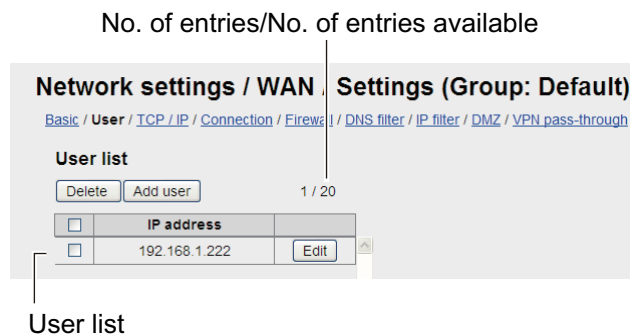

Item	Description
Delete button	Delete checked [✓] item. During PS, item is deleted after completion of PS.
Add user button	Add user to group (maximum 20). Entry screen appears.
IP address	Show IP address of registered user.
Edit button	Change user IP address. The edit screen appears.

Entry screen/Edit screen

**Network settings / WAN / Add user**

Group	Default
User	<input type="text"/> . <input type="text"/> . <input type="text"/> . <input type="text"/>

Entry screen

**Network settings / WAN / Edit user**

Group	Default
User	192 . 168 . 1 . 222

Edit screen

Item	Description
Group	Display group name.
User	Enter, change IP address (127.0.0.1, 255.255.255.255; must be different from IP address of communication unit). <b>Note:</b> if the IP addresses are the same, only one group can be registered. "192.161.1.*" and "192.168.1.10" can be registered. * is a wild-card: show network. If you registered two groups this way, the group having the narrowest range (192.168.1.10) has priority.
Add button	Register the information set. The group setting screen appears.
Save button	Save the information. The group setting screen appears. During PS, change is reflected the connection is reestablished.
Cancel button	Return to the group setting screen

**Group setting screen (TCP/IP)**

Click [TCP/IP] on the group setting screen to show the TCP/IP setting screen. Set the connection destination for each provider service.

**Network settings / WAN / Settings (Group: Default)**

[Basic](#) / [User](#) / [TCP / IP](#) / [Connection](#) / [Firewall](#) / [DNS filter](#) / [IP filter](#) / [DMZ](#) / [VPN pass-through](#)

**TCP / IP settings**

APN	<input checked="" type="checkbox"/> Use SIM APN <input type="text"/>
User account for APN	<input type="text"/>
Password for APN	<input type="text"/>
IP address (Global)	<input type="radio"/> Automatic <input type="radio"/> Manual IP address <input type="text"/> . <input type="text"/> . <input type="text"/> . <input type="text"/>
DNS server (Global)	<input type="radio"/> Automatic <input type="radio"/> Manual Primary <input type="text"/> . <input type="text"/> . <input type="text"/> . <input type="text"/> Secondary <input type="text"/> . <input type="text"/> . <input type="text"/> . <input type="text"/>

Item	Description
APN	<ul style="list-style-type: none"> <li>Use connection destination registered in the SIM card (checkmarked [✓] items).</li> <li>Use ASC II characters (other than " , ' ) for the names of connection destinations (maximum 63 characters).</li> </ul>
User account for APN	Enter username specified by provider (maximum 29 characters). Ok to leave blank.
Password for APN	Enter password specified by provider (maximum 29 characters). Ok to leave blank.
IP address (Global)	<ul style="list-style-type: none"> <li>Choose the method for obtaining IP address (Automatic, Manual).</li> <li>If Manual is selected, enter the IP Address (IPv4 address).</li> </ul>

Item	Description
DNS server (Global)	<ul style="list-style-type: none"> <li>Choose the method for obtaining the DNS server address (Automatic, Manual).</li> <li>If Manual is selected, enter the address of the Primary DNS server (IPv4 address).</li> <li>If Manual is selected, enter the address of the Secondary DNS Server (IPv4 address).</li> </ul>
Apply button	Click to apply settings and return to the WAN setting screen.
Cancel button	Click to return to the WAN setting screen.

### Group setting screen (Connection)

Click [Connection] on the Group setting screen to show the Connection settings screen. Enter connection settings as applicable.

**Network settings / WAN / Settings (Group: Default)**  
[Basic](#) / [User](#) / [TCP / IP](#) / [Connection](#) / [Firewall](#) / [DNS filter](#) / [IP filter](#) / [DMZ](#) / [VPN pass-through](#)

**Connection settings**

Auto connection	<input type="checkbox"/> Enabled
Persistent	<input checked="" type="checkbox"/> Enabled
Auto disconnection	<input checked="" type="checkbox"/> Enabled
	Condition: No Tx&Rx
	Waiting time: 10 minute(s)

Apply Cancel

Item	Description
Auto connection	Check [✓] to automatically connect the topmost items on the connection list (Standard/Browser) when power is turned on.
Persistent	Check [✓] to activate automatic reconnection when a request from the network is received. <b>Note:</b> This function will not be activated when the power is turned off manually or by a function of unit (such as [Auto disconnection] below).
Auto disconnection	<ul style="list-style-type: none"> <li>Check [✓] to automatically disconnect the group's line when below two conditions are met.</li> <li>If applied, choose disconnect condition (Any Time, No Tx&amp;Rx, No Tx, No Rx).</li> <li>If applied, enter disconnect time (001 - 999 minutes).</li> </ul>
Apply button	Click to apply settings. If group is doing PS, changes are applied after completion of PS.
Cancel button	Click to restore previous settings.

### Group setting screen (Firewall)

Click [Firewall] on the Group setting. Use this screen to block unwanted communications. Set the screen according to application and system.

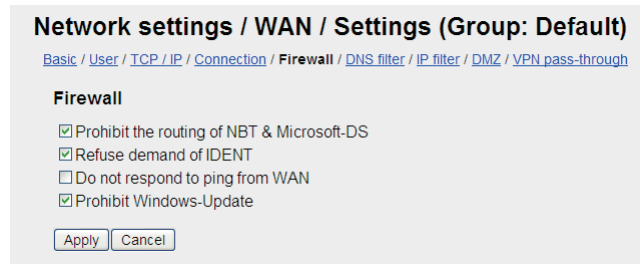

Item	Description
Prohibit the routing of NBT & Microsoft-DS	Check to prohibit NBT and Microsoft-DS. The default setting is "checked".
Refuse demand of IDENT	Refuse demand of IDENT. Place a [✓] to activate. The default setting is "checked".
Do not respond to ping from WAN	Check [✓] to prohibit response to ping from WAN. Initial setting is "checked".
Prohibit Windows-Update	Prohibit Windows® Update. Place a [✓] to activate. The default setting is "checked".
Apply button	Click to apply settings.
Cancel button	Click to return to uncheck checked items.

### Group setting screen (DNS filter)

Click [DNS filter] on the Group setting screen to show the DNS filter setting screen. This screen lets you prevent unwanted communications. Set the screen according to application and system.

No. of registrations/No. of registrations available

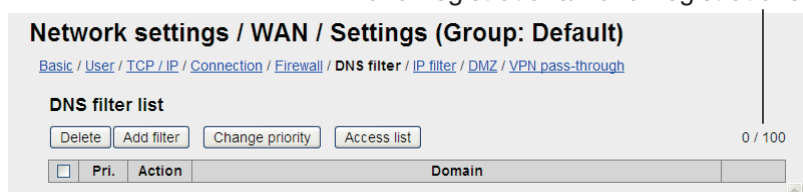

Item	Description
Delete button	Delete items with checkmarks [✓].
Add filter button	Register new DNS filter (Max. 100) on the DNS filter entry screen.
Change priority button	Change priority of DNS filters on the priority edit screen.
Access list button	The access list screen appears.
Pri.	Show priority. (The smaller the number the higher the priority.)
Action	Show actions.
Domain	Show domain(s) which is/are permitted/prohibited to access.
Edit button	Edit the DNS filter on the edit screen.

**Entry screen/Edit screen**

**Network settings / WAN / Add DNS filter**

Group	Default
Action	<input checked="" type="radio"/> Pass <input type="radio"/> Block
Domain name	<input type="text"/>

Newly register screen

**Network settings / WAN / Edit DNS filter**

Group	Default
Action	<input checked="" type="radio"/> Pass <input type="radio"/> Block
Domain name	www.furuno.com

Editing screen

Item	Description
Group	Show group name.
Action	Select actions from [Pass] and [Block].
Domain name	Enter and edit the domain name to block. If "*" is entered, access to all the domains will be blocked. (However, access by using the IP address is possible.)
Add button	Register the information entered. Go back to DNS filter setting screen.
Save button	Save the information entered. Go back to DNS filter setting screen.
Cancel button	Go back to DNS filter setting screen.

**Change priority of DNS filter screen**

**Network settings / WAN / Settings (Group: Default)**

**Change priority of DNS filter**

	Action	Domain
<input type="button" value="↑"/> <input type="button" value="↓"/>	Block	*
<input type="button" value="↑"/> <input type="button" value="↓"/>	Pass	www.furuno.com

Item	Description
<input type="button" value="↑"/> <input type="button" value="↑"/>	Raise the priority of selected item.
<input type="button" value="↓"/> <input type="button" value="↓"/>	Lower the priority of selected item.
Apply button	Apply the priority setting. Go back to DNS filter setting screen.
Cancel button	Go back to DNS filter setting screen.

**Access list screen**

**Network settings / WAN / Settings (Group: Default)**

**Access list**

Domain
xxx.xxxx.com
xxx.xxxx.com
xxx.xxxx.com
xxx.xxxx.com
www.xxxx.co.jp
www.xxxx.co.jp
www.xxxx.co.jp

Item	Description
Domain	Show domains which were accessed in the past. (max. 100)
Back button	Go back to DNS filter setting screen.

## Group setting screen (IP filter)

Click [IP filter] on the Group setting screen to show the IP filter setting screen. This screen lets you prevent unwanted communications. Set the screen according to application and system.

No. of registrations/No. of registrations available

Item	Description
Delete button	Delete items with checkmarks [✓].
Add IP filter button	Register new IP filter. (Max. 100.) The IP filter entry screen appears.
Change priority button	Change priority of IP filters. The priority edit screen appears.
Pri.	Show priority. (The smaller the number the higher the priority.)
Action	Show actions.
Dir	Select direction.
DST. address	Show the recipient address (if not set, "anywhere" is shown).
From address	Show the sender address (if not set, "anywhere" is shown).
Protocol	Display the protocol.
Area	<ul style="list-style-type: none"> <li>If [Protocol] is [Any], displays the protocol number.</li> <li>If [Protocol] is [TCP/UDP]: displays the port range.</li> <li>If [Protocol] is [TCP], [UDP]: displays the port range or port numbers for [Dst.] and [From].</li> </ul>
Edit button	Edit the IP filter. The edit screen appears.

## Entry screen/Edit screen

Entry screen





Edit screen

Item	Description
Group	Display group name
Action	Select action (Ignore, Reject, Pass). Select [Pass] to set [TCP/UDP(NAPT)] at [Protocol].
Direction	Show direction (WAN→LAN, LAN→WAN). Select [WAN→LAN] to set [TCP/UDP(NAPT)] at [Protocol].

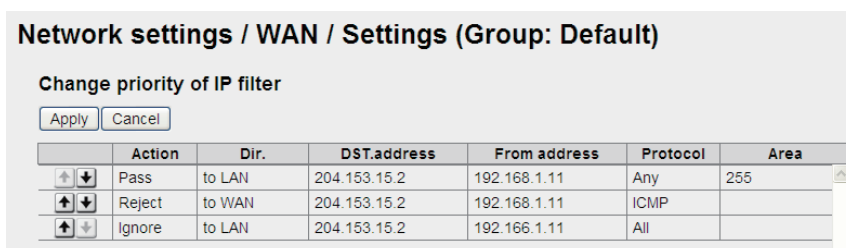
Item	Description
DST. address	Enter, edit destination address (IPv4 address).
From address	Enter, edit source address (IPv4 address).
Protocol	Select protocol (ALL, ICMP, Any, TCP/UDP, TCP/UDP(NAPT)). <ul style="list-style-type: none"> <li>• If [Protocol] is [Any], enter the protocol number (1-255).</li> <li>• If [Protocol] is [TCP/UDP] only, select TCP/UDP, TCP, UDP from list box. Enter port no. (range: 1-65535).</li> <li>• If [Protocol] is [TCP/UDP(NAPT)] only, select TCP or UDP, and enter the port numbers for [Dst.] and [From] (range: 1-65535).</li> </ul>
Add button	Register entered information. The IP filter setting screen appears.
Save button	Save entered information. The IP filter setting screen appears.
Cancel button	Return to IP filter setting screen.

**Change priority of IP filter screen**



Item	Description
 	Raise priority. (Right button: inoperative)
 	Lower priority. (Right button: inoperative)
Apply button	Save entered information. Return to the IP filter setting screen.
Cancel button	Restore previous IP filter settings.

**Group setting screen (DMZ)**

Click [DMZ] on the group setting screen to show the DMZ setting screen. Set the screen according to your system.

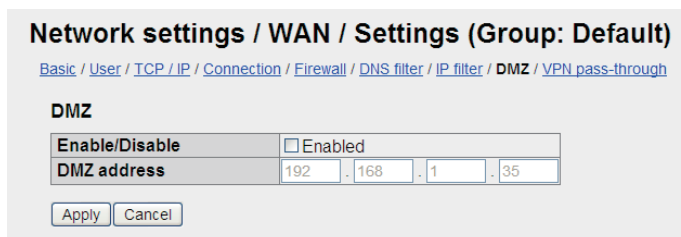

Item	Description
Enable / Disable	Check [✓] to use DMZ. Not checked in initial setting.
DMZ address	Enter DMZ address (IPv4 address).
Apply button	Apply settings.
Cancel button	Restore previous settings



### VPN pass-through screen

Click [VPN pass-through] on the group setting screen to show the VPN pass-through setting screen. Set the screen according to your system.

Item	Description
IPSec	Place a [✓] by IPSec pass-through to activate.
PPTP	Place a [✓] by PPTP pass-through to activate.
Apply button	Click to apply changes.
Cancel button	Click to ignore changes.

### Common settings screen

On the menu bar, click [Settings], [Network settings], [WAN], [Common settings] to show the Common settings setting screen.

Item	Description
Use / unuse	Check [✓] to use Upnp. Not active in initial setting.
Group	Select a group to use from a list box.
Apply button	Apply settings.
Cancel button	Restore previous settings

### Display user list

On the menu bar, click [Settings], [Network settings], [WAN], [User list] to show the user list screen.

Item	Description
Group	Show group name.
User (IP address)	Display IP address of a user registered in a group. If there is no user registered, the User column is blank.

### 6.1.10 PPPoE settings

The FELCOM can connect (dial-up connection) to the internet via PPPoE. With the Web software and PC set up for PPPoE, the dial-up application directly controls connection and disconnection of the data line. (It is not necessary to boot the Web software to connect to the internet.) The PPPoE settings must be done by **the network administrator**.

#### How to set PPPoE session

Click [Settings], [Network settings], [PPPoE] and [Session settings] to show the [PPPoE/Session settings] window.

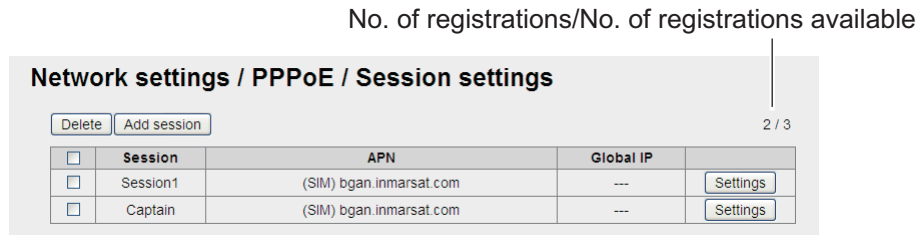

Item	Description
Delete button	Delete the item having a checkmark [✓]. A session cannot be deleted during PS*. *PS=Packet Switching
Add session button	Create a new session. Up to three sessions can be created. The creation screen appears.
Session	Display session names.
APN	Display connection destinations. (If connection destination is registered in the SIM card: "(SIM) connection destination" appears.
Global IP	<ul style="list-style-type: none"> <li>Data connection in use: Global IP address is shown.</li> <li>Not connected: "---" appears.</li> </ul>
Settings button	Show the session setting screen. The session setting screen has six types of setting screens. (Session can be registered to each screen.)

#### Entry screen

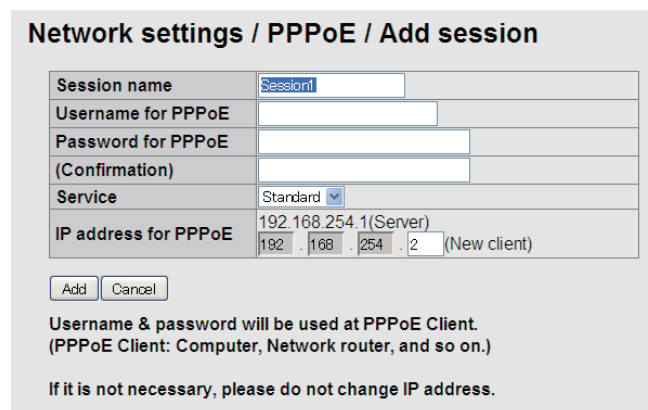

Item	Description
Session name	Enter session name.
Username for PPPoE	Enter user name *1 for PPPoE. Use ASCII characters other than space, ", ¥. Maximum of 20 characters.
Password for PPPoE	Enter password *1 for PPPoE. Use ASCII characters other than space, ", ¥. Maximum of 20 characters.

Item	Description
(Confirmation)	Enter PPPoE password.
Service	Select the service to use, among Standard, 8kbps, 16kbps, 32kbps, 64kbps, 128kbps, 256kbps <sup>*2</sup> .
IP address for PPPoE	Display IP address of PPPoE server. Enter IP address of PPPoE client (*.*.*.0,*.*.*.255. Do not set same IP address as communication unit.)
Add button	Register data. The PPPoE entry screen appears.
Cancel button	Restore previous settings of this screen.

\*1: Store user name and password in log. They are required to connect to the internet via PPPoE.

\*2: FELCOM 500 only.

### Session setting screen (basic)

Click [Basic] on the session setting screen to show the basic PPPoE settings screen.

Item	Description
<b>Session name</b>	
Session name	Display, edit name of session.
Apply button	Apply session name. (Not available during data connection.)
Cancel button	Restore previous settings. (Not available during data connection.)
<b>Username &amp; Password for PPPoE</b>	
Username for PPPoE	Display, edit user name for PPPoE. (Not available during data connection.)
Password for PPPoE	Display, edit password for PPPoE. (Not available during data connection.)
(Confirmation)	Enter PPPoE password.
Apply button	Apply username, password. (Not available during data connection.)
Cancel button	Restore previous settings. (Not available during data connection.)
<b>Data connection service</b>	
Service name	Display, edit service to use. (Not available during data connection.)
Apply button	Apply service name. (Not available during data connection.)
Cancel button	Restore previous settings. (Not available during data connection.)
Disconnect button	Disconnect data connection. (Not available before data connection.)

**Session setting screen (TCP/IP)**

Click [TCP/IP] on the session setting screen to show the TCP/IP setting screen. Set the connection name for various provider services.

**Network settings / PPPoE / Settings (Session: Session1)**

[Basic](#) / [TCP / IP](#) / [Connection](#) / [Firewall](#) / [DNS filter](#) / [IP filter](#)

**TCP / IP settings**

APN	<input checked="" type="checkbox"/> Use SIM APN <input type="text"/>
User account for APN	<input type="text"/>
Password for APN	<input type="text"/>
IP address (Global)	<input checked="" type="radio"/> Automatic <input type="radio"/> Manual IP address <input type="text"/> . <input type="text"/> . <input type="text"/> . <input type="text"/>
DNS server (Global)	<input checked="" type="radio"/> Automatic <input type="radio"/> Manual Primary <input type="text"/> . <input type="text"/> . <input type="text"/> . <input type="text"/> Secondary <input type="text"/> . <input type="text"/> . <input type="text"/> . <input type="text"/>

Item	Description
APN	<ul style="list-style-type: none"> <li>Use connection destination registered in the SIM card (checkmarked [✓] items).</li> <li>Use ASC II characters (other than “, ’) for the names of connection destinations (maximum 63 characters).</li> </ul>
User account for APN	Enter username specified by provider (maximum 29 characters). Ok to leave blank.
Password for APN	Enter password specified by provider (maximum 29 characters). Ok to leave blank.
IP address (Global)	<ul style="list-style-type: none"> <li>Choose the method for obtaining IP address (Automatic, Manual).</li> <li>If Manual is selected, enter the IP Address (IPv4 address).</li> </ul>
DNS server (Global)	<ul style="list-style-type: none"> <li>Choose the method for obtaining the DNS server address (Automatic, Manual).</li> <li>If Manual is selected, enter the address of the Primary DNS server (IPv4 address).</li> <li>If Manual is selected, enter the address of the Secondary DNS Server (IPv4 address).</li> </ul>
Apply button	Click to apply settings and return to the sessions setting screen. During data connections, settings are reflected after re-connection.
Cancel button	Click to restore previous settings and return to the sessions setting screen.

**Session setting screen (Connection)**

Click [Connection] on the session setting screen to show the Connection setting screen. Set the connection name for various provider services.

**Network settings / PPPoE / Settings (Session: Session1)**  
[Basic](#) / [TCP / IP](#) / [Connection](#) / [Firewall](#) / [DNS filter](#) / [IP filter](#)

**Connection settings**

**Auto disconnection**  Enabled  
 Condition   
 Waiting time  minute(s)

Item	Description
Auto disconnection	<ul style="list-style-type: none"> <li>Automatically disconnects the session line when below two conditions are met.</li> <li>“Any Time”, “No Tx&amp;Rx”, “No Tx” or “No Rx” is selected.</li> <li>Waiting time (001 to 999 minutes) is entered.</li> </ul>
Apply button	Click to apply settings and return to the sessions setting screen. If operated during data connections, settings are reflected after reconnection.
Cancel button	Click to restore previous settings and return to the sessions setting screen.

**Session setting screen (Firewall)**

Click [Firewall] on the session setting screen. Use this screen to block unwanted communications. Set the screen according to application and system.

**Network settings / PPPoE / Settings (Session: Session1)**  
[Basic](#) / [TCP / IP](#) / [Connection](#) / [Firewall](#) / [DNS filter](#) / [IP filter](#)

**Firewall**

Prohibit the routing of NBT & Microsoft-DS  
 Refuse demand of IDENT  
 Do not respond to ping from WAN  
 Prohibit Windows-Update

Item	Description
Prohibit the routing of NBT & Microsoft-DS	Check to prohibit NBT and Microsoft-DS. The default setting is “checked”.
Refuse demand of IDENT	Refuse demand of IDENT. Place a [✓] to activate. The default setting is “checked”.
Do not respond to ping from WAN	Check [✓] to prohibit response to ping from WAN. Initial setting is “checked”.
Prohibit Windows-Update	Prohibit Windows® Update. Place a [✓] to activate. The default setting is “checked”.
Apply button	Click to apply settings.
Cancel button	Click to restore previous settings.

### Group setting screen (DNS filter)

Click [DNS filter] on the session setting screen to show the DNS filter setting screen. This screen lets you prevent unwanted communications. Set the screen according to application and system.

No. of registrations/No. of registrations available

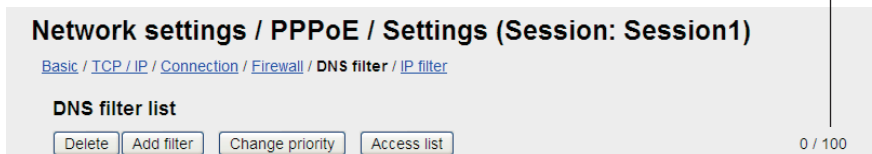

Item	Description
Delete button	Delete items with checkmarks [✓].
Add filter button	Register new DNS filter (Max. 100), on the DNS filter entry screen.
Change priority button	Change priority of DNS filters, on the priority edit screen.
Access list button	The access list screen appears.
Pri.	Show priority. (The smaller the number the higher the priority.)
Action	Show actions.
Domain	Show domain(s) which is/are permitted/prohibited to access.
Edit button	Edit the DNS filter, on the edit screen appears.

### Entry screen/Edit screen

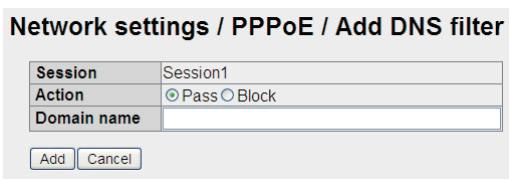

New entry screen

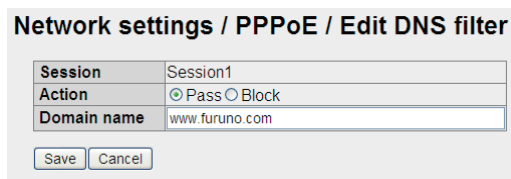



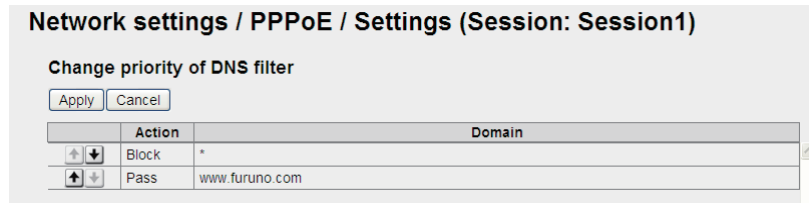

Editing screen

Item	Description
Session	Show session name.
Action	Select actions from [Pass] and [Block].
Domain name	Enter and edit the domain name to block. If "*" is entered, access to all the domains will be blocked. (However, access by using the IP address is possible.)
ADD button	Register the information entered. Go back to DNS filter setting screen.
Save button	Save the information entered. Go back to DNS filter setting screen.
Cancel button	Go back to DNS filter setting screen.

## Change priority of DNS filter screen



Item	Description
 	Raise the priority of selected item.
 	Lower the priority of selected item.
Apply button	Apply the priority setting. Go back to DNS filter setting screen.
Cancel button	Go back to DNS filter setting screen.

## Access list screen

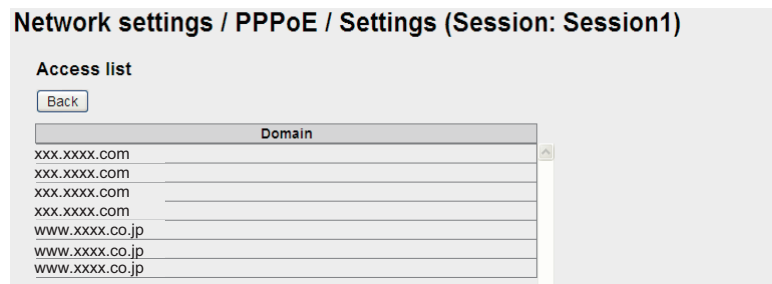

Item	Description
Domain	Shows domains which were accessed in the past. (max. 100)
Back button	Go back to DNS filter setting screen.

## **Session setting screen (IP filter)**

Click [IP filter] on the session setting screen to show the IP filter setting screen. This screen lets you prevent unwanted communications. Set the screen according to application and system.



Item	Description
Delete button	Delete items with checkmarks [✓].
Add IP filter button	Register new IP filter. (Max. 10.) The IP filter entry screen appears.
Change priority button	Change priority of IP filters. The priority edit screen appears.
Pri.	Show priority. (The smaller the number the higher the priority.)
Action	Show actions.
Dir.	Select direction.

Item	Description
DST. address	Show the recipient address (if not set, "anywhere" is shown).
From address	Show the sender address (if not set, "anywhere" is shown).
Protocol	Display the protocol.
Area	<ul style="list-style-type: none"> <li>If [Protocol] is [Any], displays the protocol number.</li> <li>If [Protocol] is [TCP/UDP]: displays the port range.</li> <li>If [Protocol] is [TCP], [UDP]: displays the port range or port numbers for [Dst.] and [From].</li> </ul>
Edit button	Edit the IP filter, on the edit screen.

### Entry screen/Edit screen

Network settings / PPPoE / Add IP filter

Session	Session1
Action	Ignore
Direction	WAN -> LAN
DST. address	192 . 168 . 254 . 1
From address	
Protocol	<input checked="" type="radio"/> ALL <input type="radio"/> ICMP <input type="radio"/> Any Protocol No : <input type="text"/> <input type="radio"/> TCP/UDP : TCP/UDP Port No : <input type="text"/> - <input type="text"/> <input type="radio"/> TCP/UDP(NAPT) : TCP Port No(Dst.) : <input type="text"/> Port No(From) : <input type="text"/>

Add Cancel

Entry screen

Network settings / PPPoE / Edit IP filter

Session	Session1
Action	Pass
Direction	WAN -> LAN
DST. address	192 . 168 . 254 . 1
From address	161 . 30 . 23 . 46
Protocol	<input type="radio"/> ALL <input type="radio"/> ICMP <input type="radio"/> Any Protocol No : <input type="text"/> <input type="radio"/> TCP/UDP : TCP/UDP Port No : <input type="text"/> - <input type="text"/> <input checked="" type="radio"/> TCP/UDP(NAPT) : UDP Port No(Dst.) : 23456 Port No(From) : 3532

Save Cancel

Edit screen

Item	Description
Session	Display session name.
Action	Select action (Ignore, Reject, Pass). Select [Pass] to set [TCP/UDP(NAPT)] in [Protocol].
Direction	Show direction (WAN→LAN, LAN→WAN). Select [WAN→LAN] to set [TCP/UDP(NAPT)] in [Protocol].
DST. address	Enter, edit destination address (IPv4 address).
From address	Enter, edit source address (IPv4 address).
Protocol	Select protocol (ALL, ICMP, Any, TCP/UDP, TCP/UDP(NAPT)). <ul style="list-style-type: none"> <li>Select protocol (ALL, ICMP, Any, TCP/UDP).</li> <li>If [Protocol] is [Any], enter the protocol number (1-255).</li> <li>If [Protocol] is [TCP/UDP] only, select TCP/UDP, TCP, UDP from list box. Enter port no. (range: 1-65535).</li> <li>If [Protocol] is [TCP/UDP(NAPT)] only, select TCP or UDP, and enter the port numbers for [Dst.] and [From] (range: 1-65535).</li> </ul>
Add button	Register entered information. The IP filter setting screen appears.
Save button	Save entered information. The IP filter setting screen appears.
Cancel button	Restore previous settings and return to the IP filter setting screen.



Change priority of IP filter screen

**Network settings / PPPoE / Settings (Session: Session1)**

Change priority of IP filter

	Action	Dir.	DST.address	From address	Protocol	Area
	Reject	to WAN	192.168.254.2	192.168.254.5	All	
	Pass	to WAN	192.168.254.2	192.168.254.5	TCP/UDP	80-80

Item	Description
	Raise priority. (Right button: inoperative)
	Lower priority. (Right button: inoperative)
Apply button	Save entered information. Return to the IP filter setting screen.
Cancel button	Restore previous IP filter settings and return to the IP filter setting screen.

Common settings screen

On the menu bar, click [Settings], [Network settings], [PPPoE], [Common settings] to show the Common settings setting screen.

**Network settings / PPPoE / Common settings**

IP address(es) for Server and Client(s)

Server	192	.	168	.	254	.	1
Client 1 (Session1)	192	.	168	.	254	.	5
Client 2 (Captain)	192	.	168	.	254	.	2

If it is not necessary, please do not change the address(es).

Timeout duration due to weak signal

5 (5-99) second(s)

The session is disconnected automatically by this timeout.

Item	Description
<b>IP address (es) for Server and Client (s)</b>	
Server	Display, edit IP address of PPPoE server.
Client 1 - 3 (session name)	Display, edit IP address of PPPoE client.
Apply button	Apply settings.
Cancel button	Restore previous settings
<b>Timeout duration due to weak signal</b>	
Timeout duration	Display, edit the timeout duration time, which automatically disconnects the line when the signal level becomes low because of antenna blocking. (5 - 99 seconds)
Apply button	Save entered information.
Cancel button	Restore previous settings.

### **PC settings (for Windows® XP)**

First set PPPoE information on the Web software then set it on the PC.

1. Click the [Start] button, [Settings] (Start menu in case of Classic display), [Control Panel].
2. Double-click [Network Connections] to show the Network connections dialog box.
3. On the Menu bar, click [File], [New Connection].



4. Click the [Next] button.

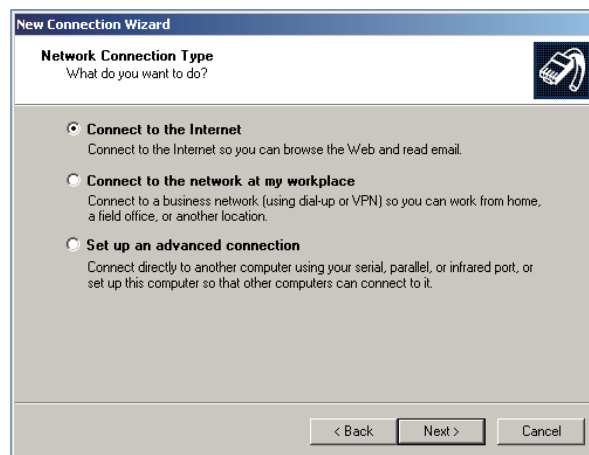

5. Select [Connect to the internet] then click the [Next] button.

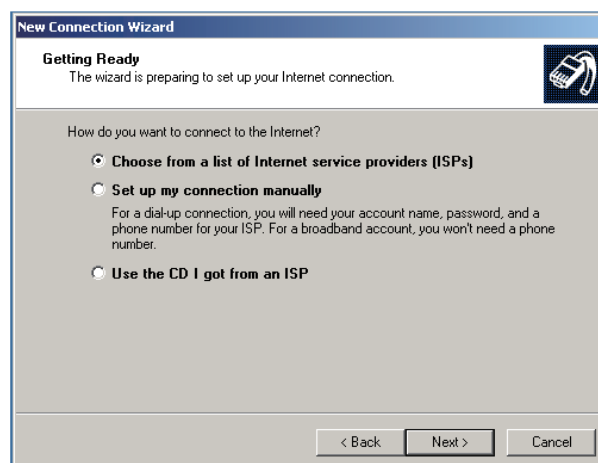

6. Select [Set up my connection manually] then click the [Next] button.

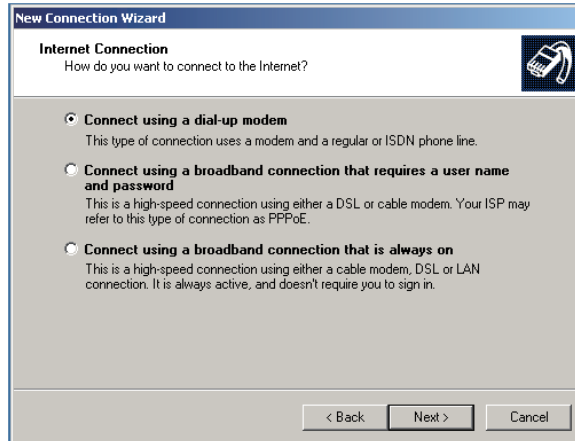

7. Select [Connect using a broadband connection that requires a user name and password] then click the [Next] button.

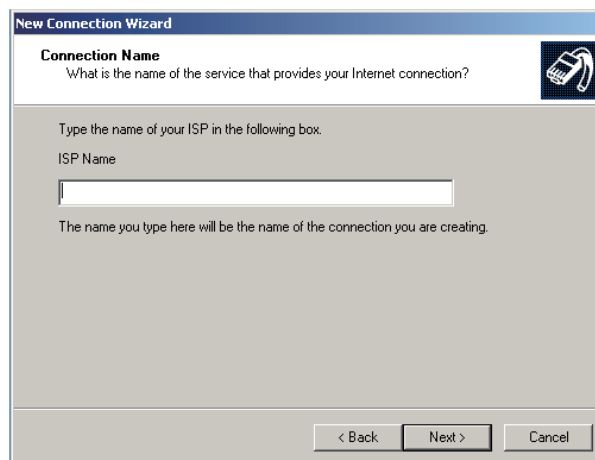

8. Enter desired name (ex. FELCOM 500) in the [ISP name] box then click the [Next] button. This is the name that will be given to the icon for PPPoE connection. If the screen shown below appears, go to step 9. If the screen does not appear go to step 10.

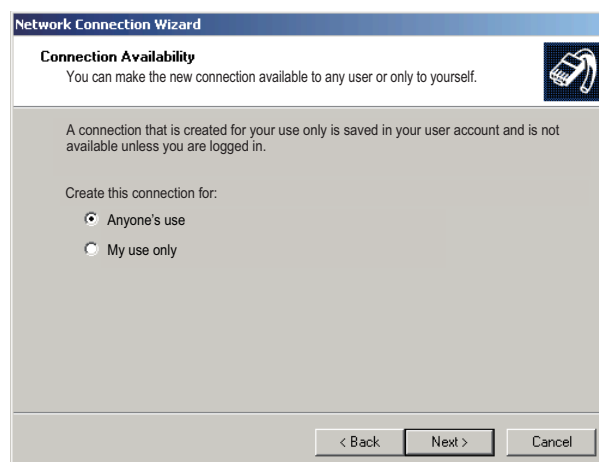

## 6. WEB FUNCTIONS

9. Select [Anyone's use] or [My use only] as applicable then click the [Next] button.

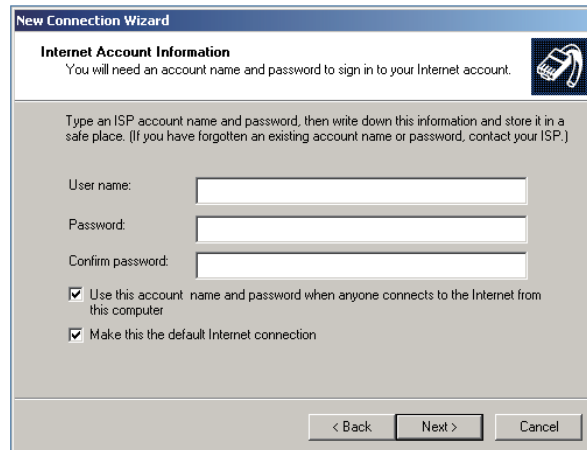

The screenshot shows the 'New Connection Wizard' window with the 'Internet Account Information' tab selected. The window title is 'New Connection Wizard'. Below the title bar, there is a sub-header 'Internet Account Information' and a small icon of a hand holding a mouse. The main text reads: 'You will need an account name and password to sign in to your Internet account.' Below this, there is a paragraph: 'Type an ISP account name and password, then write down this information and store it in a safe place. (If you have forgotten an existing account name or password, contact your ISP.)' There are three input fields: 'User name:', 'Password:', and 'Confirm password:'. Below the input fields, there are two checked checkboxes: 'Use this account name and password when anyone connects to the Internet from this computer' and 'Make this the default Internet connection'. At the bottom, there are three buttons: '< Back', 'Next >', and 'Cancel'.

10. Enter PPPoE user name in the [User name] box.
11. Enter PPPoE password in the [Password] box.
12. Enter PPPoE password again in the [Confirm password] box.
13. Click the [Next] button.



The screenshot shows the 'New Connection Wizard' window with the 'Completing the New Connection Wizard' tab selected. The window title is 'New Connection Wizard'. Below the title bar, there is a sub-header 'Completing the New Connection Wizard' and a small icon of a hand holding a mouse. The main text reads: 'You have successfully completed the steps needed to create the following connection:'. Below this, there is a section titled 'FELCOM 500' with three bullet points: 'Make this the default connection', 'Share with all users of this computer', and 'Use the same user name & password for everyone'. Below the bullet points, there is a paragraph: 'The connection will be saved in the Network Connections folder.' There is one unchecked checkbox: 'Add a shortcut to this connection to my desktop'. Below the checkbox, there is a paragraph: 'To create the connection and close this wizard, click Finish.' At the bottom, there are three buttons: '< Back', 'Finish', and 'Cancel'.

14. Click the [Finish] button. The window shown below appears.



The screenshot shows the 'Connect FELCOM 500' dialog box. The window title is 'Connect FELCOM 500'. The main area features a graphic of two laptops with a globe in between, connected by a green line. Below the graphic, there are two input fields: 'User name:' with the text 'FELCOM' and 'Password:' with the text '[To change the saved password, click here]'. Below the input fields, there is a checked checkbox: 'Save this user name and password for the following users:'. Below the checkbox, there are two radio buttons: 'Me only' and 'Anyone who uses this computer'. At the bottom, there are four buttons: 'Connect', 'Cancel', 'Properties', and 'Help'.

15. Click the [Properties] button.

16. Click the [Options] button.

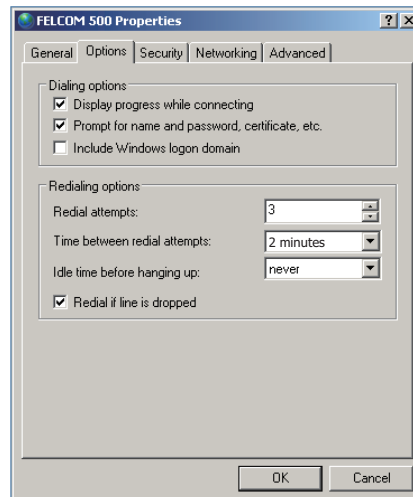

**Note:** Keep the default settings of everything in this dialog box, except [Redial attempts] and [Time between redial attempts].

17. Set [Time between redial attempts] to other than two minutes.

18. If the automatic line disconnection feature is active, set [Idle time before hanging up] to other than [Never] then click the [OK] button.

The automatic line disconnection feature automatically disconnects the line to prevent unwanted charges. The line is automatically disconnected if the receiver is not hung within the interval specified.

19. Click the Close button (x) or click the [Cancel] button.

20. Check that the PPPoE connection icon appears under Broadband in the Network Connections dialog box.

You can open the data connection line with this icon.

### **PC settings (for Windows<sup>®</sup> 7/Windows<sup>®</sup> 8)**

The procedure outlined below uses screenshots from the Windows<sup>®</sup> 7 operating system. Windows<sup>®</sup> 8 users should be aware that their displayed screens and menus may vary slightly.

1. Access the [Control Panel] on your PC.

2. Double-click [Network and Internet], then double-click [Network and Sharing Center].

For Windows<sup>®</sup> 8, select [View network status and tasks].

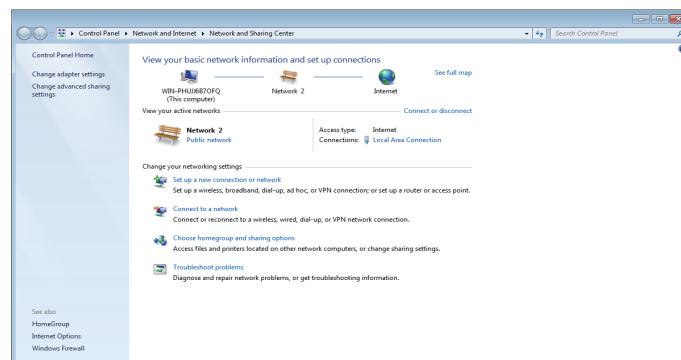

## 6. WEB FUNCTIONS

3. Left-click [Set up a new connection or network].

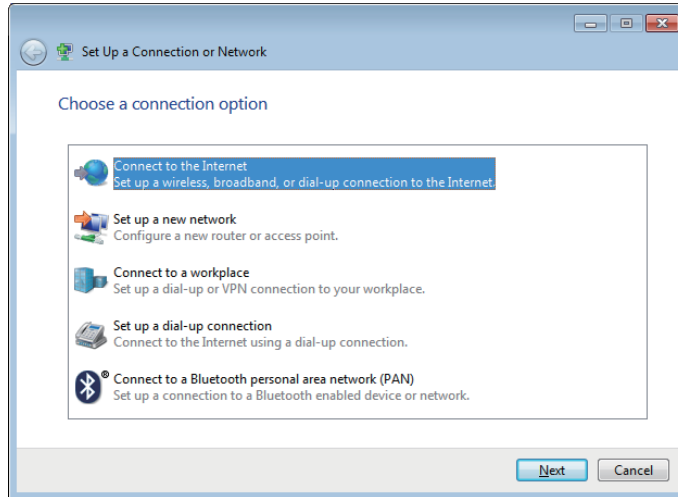

4. Select [Connect to the Internet], then left-click [Next].

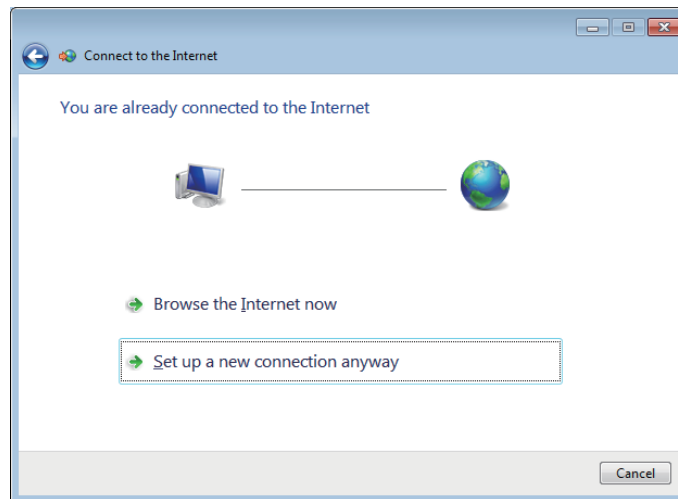

5. Left-click [Set up a new connection anyway].

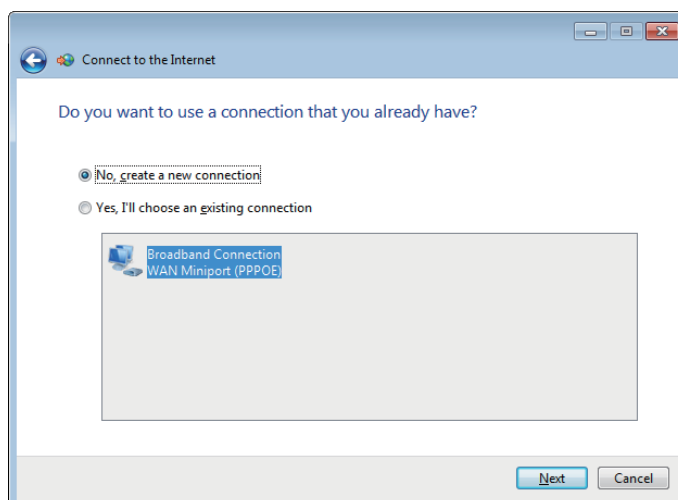

6. Select [No, create a new connection], then select [Broadband (PPPoE)], then left-click [Next].

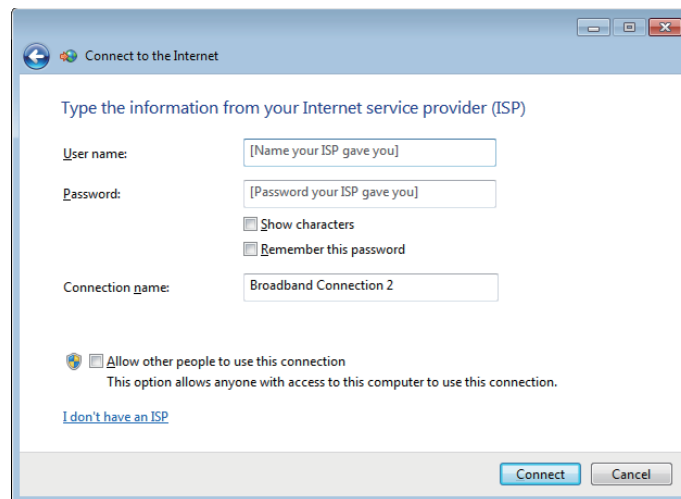

7. Enter the User name and Password according to the settings made for PPPoE. (See "Entry screen" on page 6-24).
8. You may rename the connection using the [Connection name] field. Renaming the connection is optional.
9. Left-click [Connect]. The system will now attempt to connect to the internet. On successful connection, a window similar to the one shown below will be displayed.

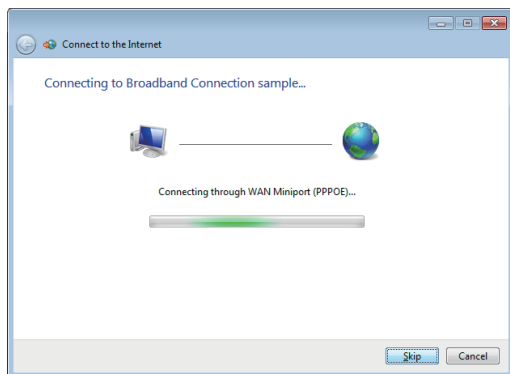

Attempting connection to the internet

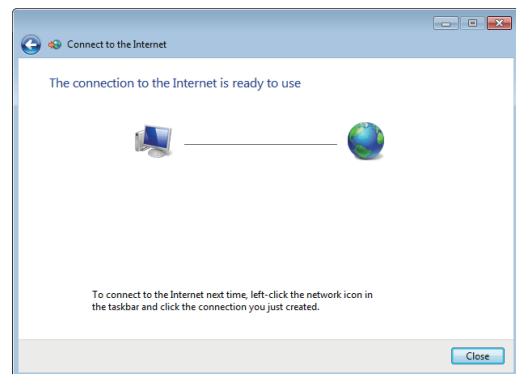

Connected to the internet

10. Left-click [Close]. A window similar to the one shown below is displayed.

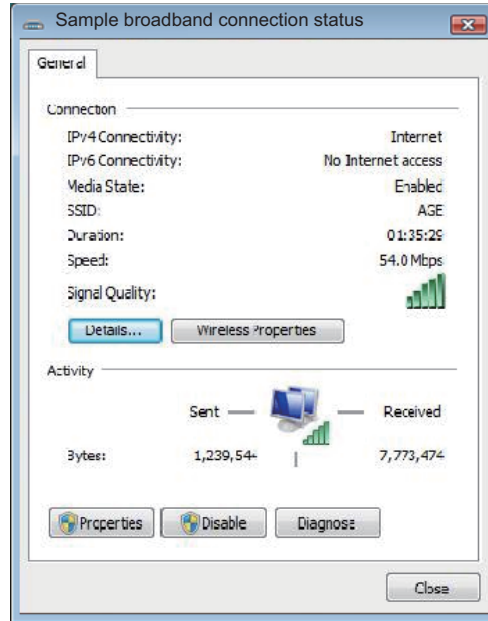

11. Left-click the [Properties] button. A window similar to the one shown below is displayed.

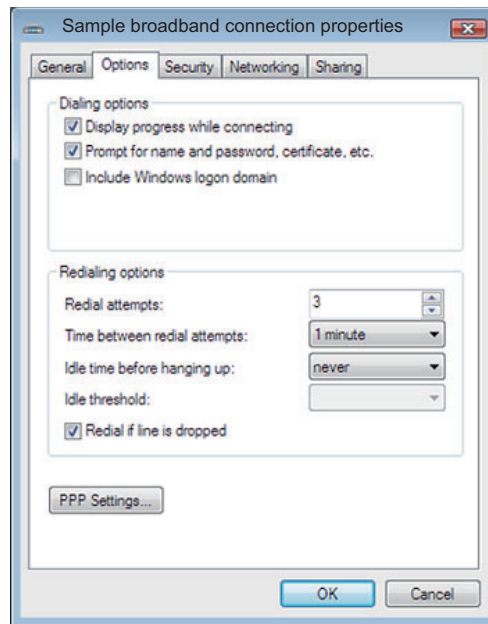

12. Left-click the [Options] tab at the top of the [Properties] window.

**Note:** Only change the settings for [Idle time before hanging up] and [Time between redial attempts] in the [Redialing options] section of the window. Leave all other settings at their default.

13. Adjust the [Time between redial attempts] to 2 minutes or more.

14. Adjust the [Idle time before hanging up] setting to [Never], then left-click the [OK] button.

The [Idle time before hanging up] setting can be used to avoid unnecessary costs due to lines left open. When the line is idle and the time set here lapses, the line is automatically closed.

15. Close all open windows.

16. Check that the PPPoE connection icon appears under Broadband in the Network Connections dialog box. You can open the data connection line with this icon.



## How to connect to the internet via PPPoE (for Windows® XP)

Connect to the internet with a dial-up application, for example, Internet Explorer®.

1. Open the dial-up application and the [Dial-up Connection] dialog box appears.

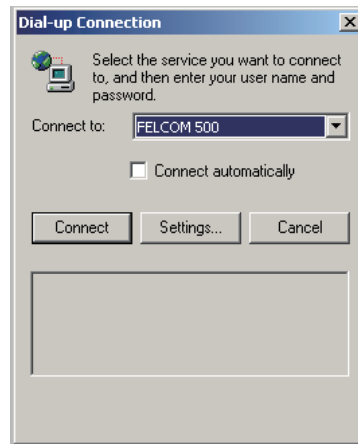

**Note 1:** If the Dial-up connection dialog box does not appear, click [Tools], [Internet options] on the menu bar of the Internet Explorer®. Click [Connections] then confirm that [Dial whenever a network connection is not present] is checked.

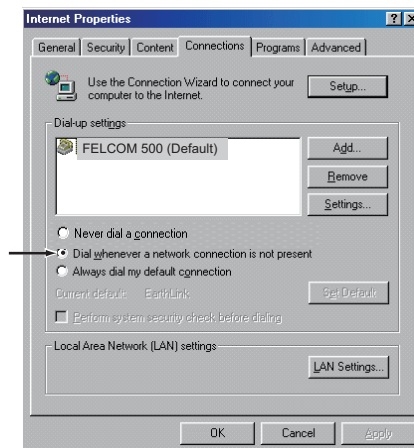

**Note 2:** Check [Connect automatically] on the [Dial-up Connection] dialog box to automatically skip step 3 in this procedure.

2. Click the [Connect] button to show the following dialog box.



**Note:** If you have registered several sessions to the Web software, enter applicable user name and password to connect to desired service.

## 6. WEB FUNCTIONS

3. Click the [Connect] button to start the data connection. The task bar shows [Connected to \*\*\*] (\*\*\*) is the name on the icon for PPPoE connection) if you are connected to the internet.
4. To disconnect the data connection, click the icon for PPPoE connection (🌐) on the task bar.

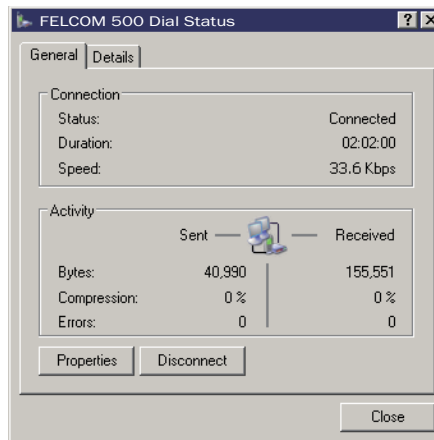

5. Click the [Disconnect] button to disconnect the data connection. Closing the application does not disconnect the line.

### **How to connect to the internet via PPPoE (for Windows® 7/Windows® 8)**

The procedure outlined below uses screenshots from the Windows® 7 operating system. Windows® 8 users should be aware that their displayed screens and menus may vary slightly.

1. Access the [Control Panel] on your PC.
2. Double-click [Network and Internet], then double-click [Network and Sharing Center].  
For Windows® 8, select [View network status and tasks].
3. Left-click [Connect to a network]. A list of available networks is displayed.

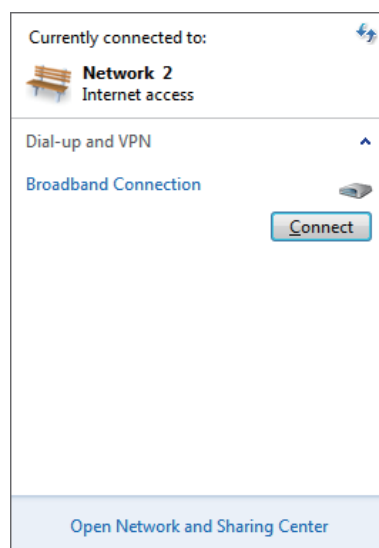

- Left-click the appropriate PPPoE network connection, then left-click the [Connect] button which is displayed. A window similar to the one shown below is displayed.

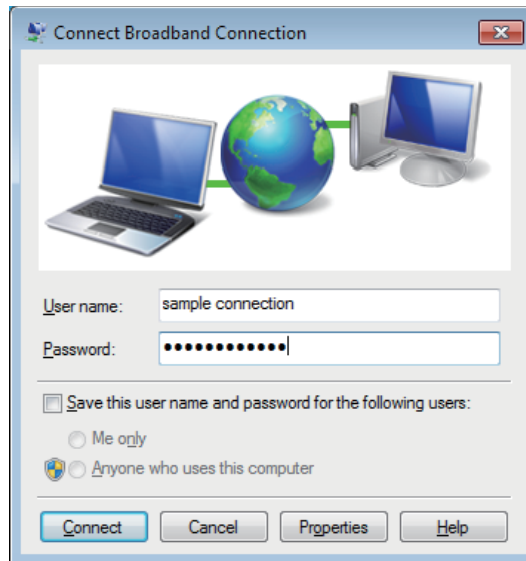

- Input the PPPoE username and password, then left-click the [Connect] button.

### **How to show the PPPoE status monitor display**

The PPPoE status monitor display shows the packet communication volume for the current PPPoE session.

- Start the Internet Explorer® and connect to the internet with PPPoE as shown in the procedure on page 6-39.
- Enter `http://192.168.254.1` in the address bar then press the [Enter] key to show the PPPoE status monitor display.

### **6.1.11 How to set the Bridge mode**

The Bridge mode uses the global IP address assigned by Inmarsat to communicate via the specified LAN port on the user terminal. The user terminal can not set the NAT or Firewall.

**Note 1:** Set Firewall and traffic limitation at the user's network device.

**Note 2:** The Bridge mode settings must be done by **the network administrator**.

- Click [Settings] in the menu bar.
- Click [Network settings].
- Click [Bridge mode].

No. of registrations/No. of registrations available

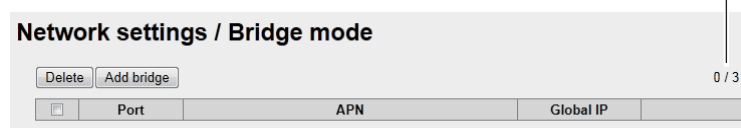

6. WEB FUNCTIONS

4. Click the [Add bridge] button.

**Network settings / Bridge mode / Edit bridge**

Port	<input checked="" type="radio"/> LAN1 <input type="radio"/> LAN2 <input type="radio"/> LAN3 (used) <input type="radio"/> LAN4
Connection	<input type="checkbox"/> Always on
INSD support ?	<input checked="" type="checkbox"/> Enable Reserved IP address: 192 . 168 . 1 . 3
Service	8k streaming
APN	<input checked="" type="checkbox"/> (SIM APN) bgan.inmarsat.com
User account for APN	<input type="text"/>
Password for APN	<input type="text"/>
IP address (Global)	<input checked="" type="radio"/> Automatic <input type="radio"/> Manual IP address: . . . .
DNS server (Global)	<input checked="" type="radio"/> Automatic <input type="radio"/> Manual Primary: . . . . Secondary: . . . .

Save Cancel

5. Set as follows:

Item	Description
Port	<ul style="list-style-type: none"> <li>Select LAN port (LAN1, LAN2, LAN3, LAN4).</li> <li>LAN port already used can not be selected.</li> </ul>
Connection	<ul style="list-style-type: none"> <li>Constant connection: Put a [✓] in the check-box beside [Always on].</li> <li>Irregular connection: Remove the checkmark beside [Always on].</li> </ul>
Service	<p>Select the service among Standard data, 8kbps Streaming, 16kbps Streaming, 32kbps Streaming, 64kbps Streaming, 128kbps Streaming, 256kbps Streaming*.</p> <p>*: For FELCOM500 only</p>
iNSD support	<ul style="list-style-type: none"> <li>Put a [✓] mark in the check-box beside [Enable] to connect with the iNSD.</li> <li>Set the IP address which is different from the IP address on the same network as the communication unit</li> </ul> <p><b>Note 1:</b> The iNSD device allows access to the Fleet Express service. Contact Inmarsat or your provider for more details.</p> <p><b>Note 2:</b> When you put a [✓] mark in the check-box beside [Enable], Internet access is enabled for terminals other than the terminal which has a global IP address assigned by Inmarsat.</p> <p><b>Note 3:</b> Where the Fleet Express service is not used, do not put a [✓] mark in the check-box beside [Enable].</p>
APN	<ul style="list-style-type: none"> <li>Enter the access point name in ASCII format, using a maximum of 63 characters (other than [“], [’]).</li> <li>Access point cannot be entered when a [✓] is put in the check-box beside [SIM APN].</li> </ul>
User account for APN	Enter the user name specified by provider (alphanumeric and symbol, a maximum of 29 characters).
Password for APN	Enter the user name specified by provider (alphanumeric and symbol, a maximum of 29 characters).
IP address (Global)	<ul style="list-style-type: none"> <li>Select how to get the IP address, [Automatic] or [Manual].</li> <li>Enter the IP address when [Manual] is selected.</li> </ul>

Item	Description
DNS server (Global)	<ul style="list-style-type: none"> <li>• Select how to get the address of DNS server, [Automatic] or [Manual].</li> <li>• Enter the IP address of the priority DNS server when [Manual] is selected.</li> <li>• Enter the IP address of the alternative DNS server when [Manual] is selected.</li> </ul>

6. Click the [Add] button. The message "Comms will be disabled until finishing initializing and restarting CmmUnt. Are you sure you want to execute?" appears.
7. Click the [OK] button. After completing the setting, the message "Completed" appears.
8. Click the [OK] button again.
9. Restart FELCOM250/500. Reload the browser and then the main display appears.

### 6.1.12 How to set the Remote access

The Remote access lets you access the web menu settings of FELCOM250/500 via internet.

**Note 1:** The following settings are recommended:

- Select a port number that is not normally used.
- Use an IP address which has access.

**Note 2:** The Remote access settings must be done by **the network administrator**.

1. Click [Settings] in the menu bar.
2. Click [Network settings].
3. Click [Remote access].

4. Put the [✓] mark in the check-box beside [Enable]. To deactivate this function, remove the checkmark.
5. Enter the port number in [Port number] (1-65535).  
Set the port number and then access `http://<Global IP address>:<Port number>`.
6. Set [Trusted IP address] as appropriate. Enter the IP address allowed to access. If no IP address is entered, all IP addresses can access the web menu of FELCOM250/500.
7. Click the [Apply] button. After completing the setting, the message "Completed" appears.
8. Click the [OK] button.

### 6.1.13 How to change the password

Do the following procedure to change the SMS password, log password, and Administrator password. Write down the password in log so as not to forget the password. If the password is lost, contact the dealer or retail supplier.

1. Click [Settings] in the menu bar.
2. Click [Password]. The following password setting screen appears.

The screenshot shows a web interface for password settings. It is titled "Password" and is divided into three main sections:

- SMS server:** Contains two input fields labeled "New password" and "(Confirmation)", and two buttons labeled "Apply" and "Cancel".
- Log view:** Contains two input fields labeled "New password" and "(Confirmation)", and two buttons labeled "Apply" and "Cancel".
- Administrator:** Contains two input fields labeled "New password" and "(Confirmation)", and two buttons labeled "Apply" and "Cancel".

3. Enter the new password in the [New password] field.  
Solid black circles appear as characters. The number of characters is limited as follows:
  - SMS password: Max. 8 characters
  - Log, Administrator password: 4-8 characters
4. Enter the new password again in the [Confirmation] field.
5. Click the [Apply] button. The message "Setting Completed" appears.  
**Note:** The message "New Password isn't corresponding" appears when the password entered in the [New password] field does not match that entered in the [Confirmation] fields.
6. Click the [OK] button.

### 6.1.14 How to forward the log to a PC

You can send the log to a PC with the syslog application installed. Point the IP address at the computer and send.

1. Click [Settings] in the menu bar.
2. Click [Syslog transfer] The following system log screen is displayed:

Syslog transfer	
Transfer log	<input type="checkbox"/> Enable
Transfer address	<input type="text"/> . <input type="text"/> . <input type="text"/> . <input type="text"/>
Log level	<input checked="" type="checkbox"/> Error <input checked="" type="checkbox"/> Warning <input checked="" type="checkbox"/> Notice
<input type="button" value="Apply"/> <input type="button" value="Cancel"/>	

3. Put a [✓] in the check-box beside [Transfer log].
4. Enter the IP address of the computer to send to in the [Transfer address] field.
5. Put a [✓] by the log to send in the [Log level] field.
6. When finished, click the [Apply] button. The message "The Comm. Unit will restart automatically to apply this setting. Press OK to continue." displays.
7. Click the [OK] button. The message "Completed. Please wait a moment for re-starting." displays.
8. Click the [OK] button. FELCOM 250/500 restarts.

## 6.2 Device List

All devices connected to the same network can be displayed. The link setting of auto detected handset and devices registered on device list can be changed with the Web software.

### 6.2.1 How to detect devices automatically

1. Click [Device] in the menu bar.
2. Click [Auto detect]. A list is displayed of all connected devices.

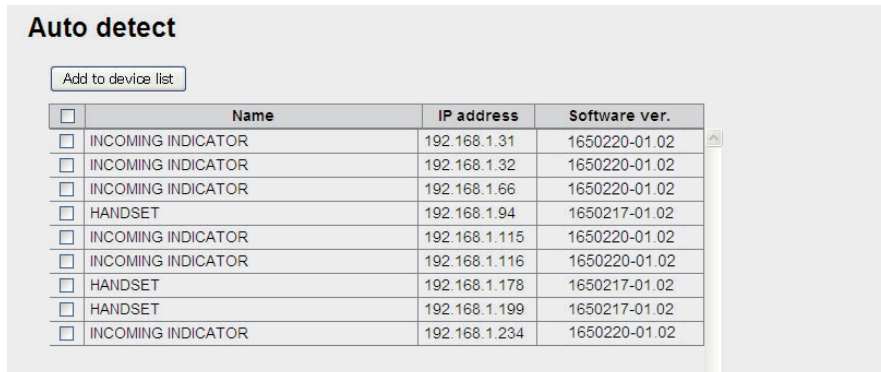

3. Place a [✓] in the check-box next to the device to add to the Device list.
4. Click [Add to device list]. The message "Completed" appears.  
**Note:** When you try to add a new device, if the number of items on the Device list is already at 20 items, the message "It exceeds the maximum number of the Device list." appears and the device is not added.
5. Click the [OK] button to close the message.  
 The device chosen in step 3 is added to the Device list.



## 6.2.2 How to change the link setting in the Device list

Handsets, Incoming Indicators, etc., are registered to the Device list, and can be changed with the Web software. Also, equipment is connected to a web server can be manually registered with the Web software. A maximum of 20 items can be registered.

1. Click [Device] in the menu bar.
2. Click [Device list] to show the list of registered items.

**Device list**

Delete Add list 4 / 20

<input type="checkbox"/>	URL	Name	IP address	Software ver.	
<input type="checkbox"/>	URL	HANDSET	192.168.1.87	1650217-01.02	Edit
<input type="checkbox"/>	URL	HANDSET	192.168.1.199	1650217-01.02	Edit
<input type="checkbox"/>	URL	INCOMING INDICATOR	192.168.1.31	1650220-01.02	Edit
<input type="checkbox"/>	URL	HANDSET	192.168.1.34	1650217-01.02	Edit

3. To select the item to change the link information, click the [URL] button on the left side.

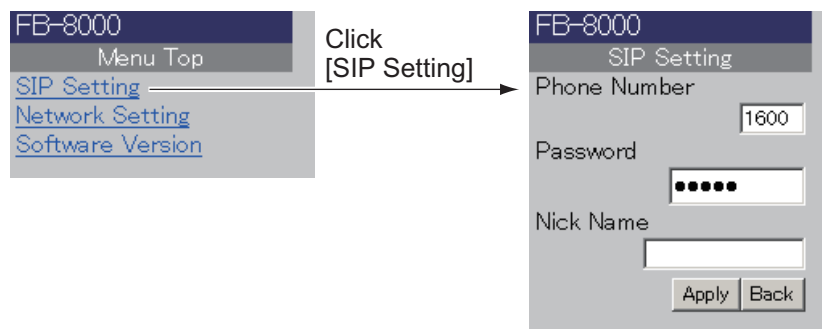

If [Handset] is selected

**Device list / Incoming indicator**

**Settings**

Obtain  Automatic  Manual

IP address  .  .  .

Subnet mask 255.255.255.0/24

Apply Cancel

**Information**

MAC address 00:40:9d:39:c3:8a  
SW version 1650220-01.06

If [INCOMING INDICATOR] is selected

4. Edit settings as desired.
5. Click the [Return] button on the top of the web browser to return to the Device list.

**How to manually register an item on the Device list**

You can manually register equipment on the web server to the device list.

1. Open the Device list.
2. Click the [Add list] button.

The screenshot shows a dialog box titled "Device list / Add list". At the top left, there are two buttons: "Add" and "Cancel". Below them are two input fields. The first field is labeled "Name" and has a "Mandatory" label to its left. The second field is labeled "Destination" and has a "Mandatory" label to its left. The "Destination" field contains the text "http://".

3. Enter the name in the [Name] field (max. 50 characters).
4. Enter the destination URL in the [Destination] field (max. 192 characters).
5. Click the [Add] button.
6. Click the [Ok] button to erase the message.

**How to edit an item on the Device list**

You can edit the name or destination URL of a device. However, the destination of an incoming indicator cannot be edited.

1. Open the Device list.
2. Click the [Edit] button to the right of the device to select the item to edit.
3. Edit the name or destination URL of the device.
4. Click the [Save] button.
5. Click the [OK] button to erase the message.

**How to delete an item from the Device list**

You can delete one or all of the items from the Device list.

1. Open the Device list.
2. Place a [✓] in the box to the left of the item to delete (you can select multiple items). To Delete all items place a [✓] in the box on the left side of [URL] at the top of the list. All items will be checked.
3. Click the [Delete] button.
4. Click the [OK] button.
5. Click the [OK] button again to close the message.

## 6.3 How to Save, Load Settings

The following web software related settings can be saved.

- Main: Search option for Satellite search
- SMS: Signature of SMS settings
- Settings: All Basic settings
- Settings: All PBX settings
- Settings: All Network settings

### 6.3.1 How to save settings

Do the following to save settings.

1. Click [Settings] in the menu bar.
2. Click [Import/Export] to show the following screen.

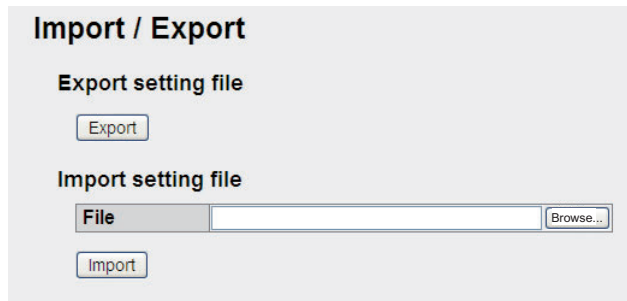

**Import / Export**

**Export setting file**

Export

**Import setting file**

File  Browse...

Import

3. Click the [Export] button
4. Follow the instructions in the dialog box to save settings.

### 6.3.2 How to load settings

Do the following to load settings.

1. Click [Settings] in the menu bar.
2. Click [Import/Export].
3. Click the [Browse...] button.
4. Select the file to load.
5. Click the [Import] button. The message "The Comm. Unit will restart automatically to apply this setting. Press OK to continue." appears.
6. Click the [OK] button. When completed, the message "Completed. Please wait a moment for restarting" appears and then the communication unit restarts. The main screen appears when restart is completed.

This page is intentionally left blank.

# 7. MAINTENANCE AND TROUBLESHOOTING

This chapter describes maintenance and troubleshooting procedures to keep the equipment in good condition and restore normal operation in case of trouble.

## WARNING

**ELECTRICAL SHOCK HAZARD**  
Do not open the equipment.

This equipment uses high voltage that can cause electrical shock. Only qualified persons can work inside the equipment.

## NOTICE

**Do not apply paint, anti-corrosive sealant or contact spray to plastic parts or equipment coating.**

Those items contain products that can damage plastic parts and equipment coating.

## 7.1 Periodical Maintenance

Check item	Checkpoint	Countermeasure
Cable (Connector)	Check that all cables are connected tightly and free of corrosion.	If necessary, connect loosened cables, etc. If a cable is damaged, replace immediately.
Ground terminal	Check that the ground wire connected to the terminal is tightly fastened and the terminal is free of dust, dirt and rust.	Remove dust and dirt from the terminal. Tighten the wire if it has loosened.
Communications unit Handset	Check that there is no dust or dirt on the unit.	Clean the unit with a soft, dry cloth. If the unit is very dirty, clean with water-diluted mild detergent and soft cloth. Wipe unit with clean cloth after on a wet cloth then with a dry cloth. Do not use alcohol or paint thinners, as they can remove writing and marks on the panel.
Handset LCD Screen	Check the screen for dust and dirt, and that there are no cracks on the screen.	Wipe the LCD carefully to prevent scratching, using tissue paper and an LCD cleaner. To remove dirt or salt deposits, use an LCD cleaner, wiping slowly with tissue paper so as to dissolve the dirt or salt. Change paper frequently so the salt or dirt will not scratch the LCD. Do not use solvents such as thinner, acetone or benzene for cleaning.

## 7.2 How to Change the Fuse



### WARNING

**Use the proper fuse.**

Use of a wrong fuse can result in damage to the equipment and cause fire.

The fuse in the power cable protects the unit from overcurrent. If you cannot turn on the power, check if the fuse has blown. If the fuse has blown find the cause before replacing the fuse. If the fuse blows again after replacement, call your dealer for advice.

Part	Type	Code number	Description
Fuse	FGBO-A 125V 15A PBF	000-155-827-10	for 12 VDC
	FGBO-A 125V 7A PBF	000-164-965-10	for 24 VDC

## 7.3 Communication Unit (CU) LED Lamps

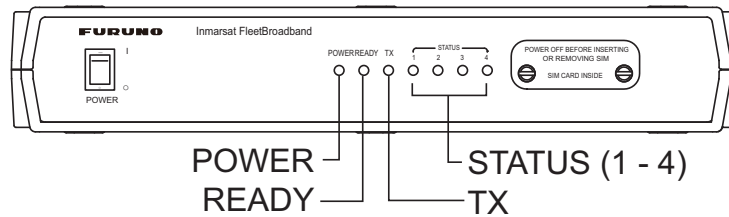

The communication Unit LED lamps indicate the status of the antenna unit and the CU. Refer to the following table:

### Communication Unit Lamp Status

LED	Lamp Status	Status	Note
Power	On	Power is On	Normal state
	Off	Power is Off	
Ready	On	Tracking satellite	Normal state
	Flashing (1 sec. interval)	Detecting satellite signal	Immediately after power on
	Off	Searching for satellite	Immediately after power on
Tx	On	Transmitting	Normal state
	Off	Not transmitting	Normal state
Status 1	On	Modem in communication unit is operating normally	Normal state
	Flashing (1 sec. interval)	Problem with the modem	Warning
	Flashing (0.2 sec. interval)	Modem has significant problem	Error
Status 2	On	HUB in communication unit is operating normally	Normal state
	Flashing (1 sec. interval)	Problem with one part of the HUB	Warning
	Flashing (0.2 sec. interval)	HUB has significant problem	Error
Status 3	On	Antenna is operating normally	Normal state
	Flashing (1 sec. interval)	Problem with one part of the antenna	Warning
	Flashing (0.2 sec. interval)	Antenna has significant problem	Error
Status 4	On	Handset is operating normally	Normal state
	Flashing (1 sec. interval)	Problem with the handset	Warning
	Flashing (0.2 sec. interval)	Handset has significant problem	Error

If one of the Status LEDs 1- 4 is flashing, open the Web software on the PC to check the message. (See section 7.6.)

## 7.4 Troubleshooting

If you think the equipment is not operating normally, do the checks in the table below to find the possible causes. If repair of the equipment is necessary report the result of the troubleshooting to the service technician. If you are asked the IMEI (International Mobile Equipment Identify) number, do the following to find it.

- Handset: At the idle screen, press [\*], [#], [0], [6], [#].
- Web software: On the menu bar, click [Main], [System information].

### Troubleshooting

Condition	Check point
No power (POWER lamp on communication unit does not illuminate).	<ul style="list-style-type: none"> <li>• Check if the fuse has blown.</li> <li>• Check if the power connector has loosened.</li> <li>• Check if the power cable is rusted or damaged.</li> <li>• Check if the power cable is damaged.</li> <li>• Check if the voltage of the ship battery is within range (10.8 - 31.2V DC).</li> </ul>
Nothing displays on handset screen.	<ul style="list-style-type: none"> <li>• Check if the handset cable is properly connected to the communication unit.</li> <li>• Check the brightness level of screen is not too dark</li> </ul>
The handset keys do not respond.	Push and hold the  key for 3 seconds to restart the handset. If keys continue to not respond after restart, contact your dealer.
Does not become [Ready] status.	<ul style="list-style-type: none"> <li>• Check if the antenna cable is properly connected.</li> <li>• Check that there are no objects blocking the signal between antenna and satellite.</li> <li>• In the Web software, do Main → satellite search to do a manual satellite search.</li> <li>• Check if the ship position data is correct ("No fix" or "No data" appears, etc.).</li> <li>• In the Web software, do Settings → Basic Settings → GPS to check if the backup GPS is set correctly.</li> </ul>
"Data connection (***) was failed 5 times (automatic retry cancelled)." displays on handset screen.	<ul style="list-style-type: none"> <li>• Check with your SIM provider if the service option for data communication is active.</li> <li>• Connect to the Internet again.</li> <li>• Restart the FELCOM250/500.</li> <li>• Check if there is no obstacles between antenna and satellite.</li> <li>• In the Web software, check that the data connection settings are correct from the Settings → Network settings → WAN → Group settings → TCP/IP setting screen.</li> </ul>
Cannot make external call.	<ul style="list-style-type: none"> <li>• Check telephone number. Land subscriber: [00], country code, tel. no. Ship subscriber: [00], [870], (ocean area code), Inmarsat no.</li> <li>• Check if the handset cable is properly connected to the communication unit.</li> <li>• Check if the handset screen shows [V:Ready / 0].</li> <li>• Wait a while, and retry.</li> <li>• In the Web software, check Settings → PBX Settings → Extension to check that "Extension" or "Incoming" does not appear in the [Call limit] setting.</li> <li>• Check that same extension number and password are entered in the handset and web software.<b>Handset:</b> Settings → 3 SIP → 1 Client set. <b>Web software:</b> Settings → PBX settings → Extension</li> <li>• Check if the [Access] and [Filter] box for the handset (or terminal) of Settings → PBX settings → Extension does not have [✓] mark.</li> </ul>



Condition	Check point
Cannot make internal call.	<ul style="list-style-type: none"> <li>• Check that the handset and/or analog phone cables are properly connected to the communication unit.</li> <li>• If using an analog phone, do Settings → Basic settings → Analog ports on the Web software to see that the phone number is not wrong.</li> <li>• In the web software, do Settings → PBX settings → Extension to check that "Outside" or "Incoming" does not appear in the [Call limit] setting.</li> <li>• Check that same extension number and password are entered in the handset and web software.</li> </ul> <p><b>Handset:</b> Settings → 3 SIP → 1 Client set.</p> <p><b>Web software:</b> Settings → PBX settings → Extension</p>
Cannot use the internet.	<ul style="list-style-type: none"> <li>• Check that the handset screen displays [D: Connected] and the Web software displays [Data connection Connected].</li> <li>• Check internet connection settings on the PC.</li> </ul>
Incoming Indicator does not sound.	<ul style="list-style-type: none"> <li>• Check that the cable between incoming indicator and Communication unit is correctly connected.</li> <li>• Adjust the incoming indicator volume. Press ▲ to increase the volume.</li> <li>• In the Web software, do Settings → Basic settings → Incoming indicator (enabled service) and see if Voice (telephone), FAX, ISDN UDI, ISDN RDI (UDI/RDI FELCOM 500 only) are checked.</li> </ul>
The printing of the fax is wavy.	Put anti-vibration material under the fax to reduce the vibration.
Takes lot of time to communicate with fax.	Activate the safety communication mode on FAX-2840, referring to the operator's manual of the fax.

## 7.5 Self Test

If the communication unit is acting unusual, do a self test to check function. If service is necessary report the results of the self test to the service technician.

### 7.5.1 Handset self test

1. At the idle screen, press the **Enter** key to open the main menu.
2. Press **▼** to select the [Settings] icon and press the **Enter** key.
3. Press **6** to select [Self test]. The operation password prompt appears.
4. Press the **Enter** key.
5. Enter the operation password and press the **Enter** key.
6. Press **▼** to select [OK] and press the **Enter** key. The following confirmation screen appears:

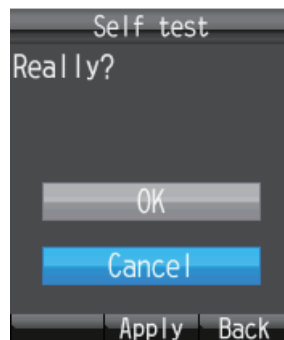

7. Press **▲** to select [OK] and press the **Enter** key to start the handset self test. The test goes in the sequence shown below.

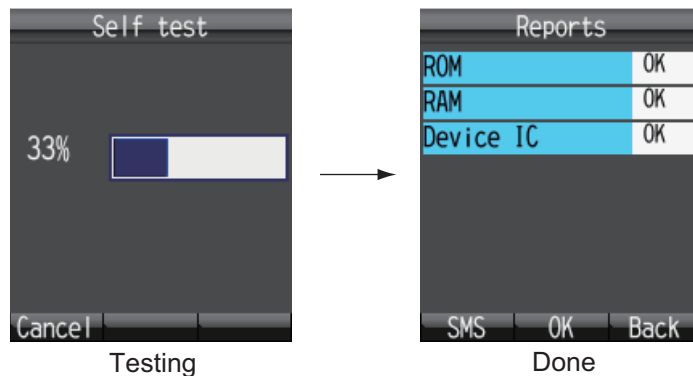

The results of the ROM, RAM, and Device IC are shown as [OK] (normal) or [NG] (No Good, error). For error, consult your dealer for advice.

8. To close the test results, press the **Enter** key. The [Settings] menu appears.
9. Press the **Ⓞ** key to close the menu.

**Note:** To send the results of the test, press the **📞** key to show [Create SMS], where you can create and SMS message.

## 7.5.2 Communication unit and antenna unit self test

The communication unit and antenna unit can be tested with the Web software.

1. Login as Administrator in the Web software.
2. Click [Selftest] in the menu bar to show the [Selftest] screen.

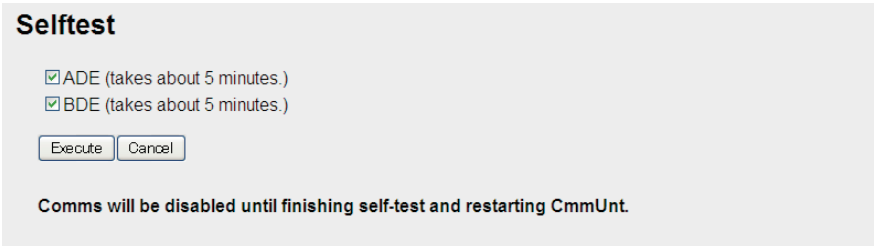

3. To test the antenna unit, select [ADE]. To test the Communication Unit, select [BDE].
4. Click [Execute].
5. Click [OK] to start the self test. Each test takes approximately five minutes to complete.

**Note:** Do not navigate to another screen in the web browser or reset the power during the self test.

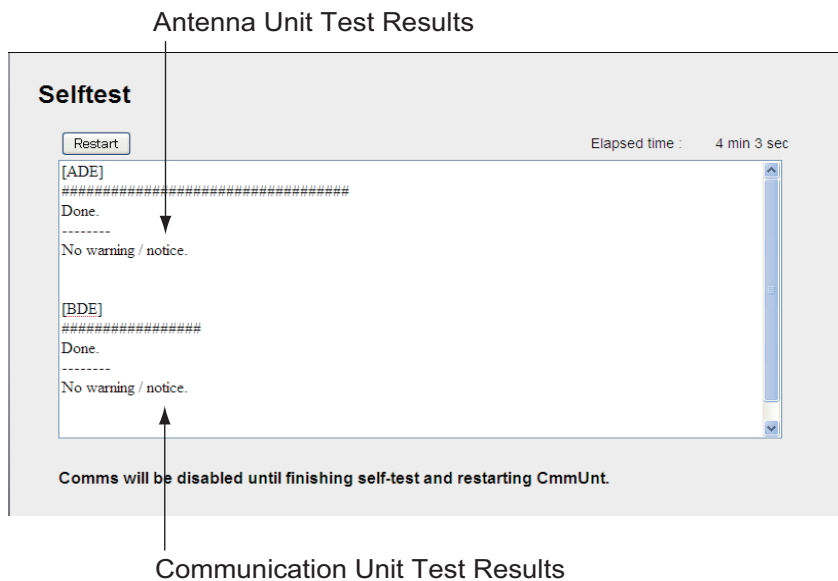

Ensure that the test results for all items are [No warning/notice]. If [No warning/ Notice] does not display for all items, contact your dealer.

6. Click the [Restart] button to restart the system.

**Note:** The communication is disabled when you execute the self test. After completing the self-test, click the [Restart] button.

## 7.6 Error/Warning Messages

When a problem occurs, an Error or Warning message appears in the system message display area. Detailed Error and Warning messages (max 100 messages) appear in [Main] → [Error information]. The location of the occurring error/warning message is displayed, so it is possible to specify and indicate the faulty module.

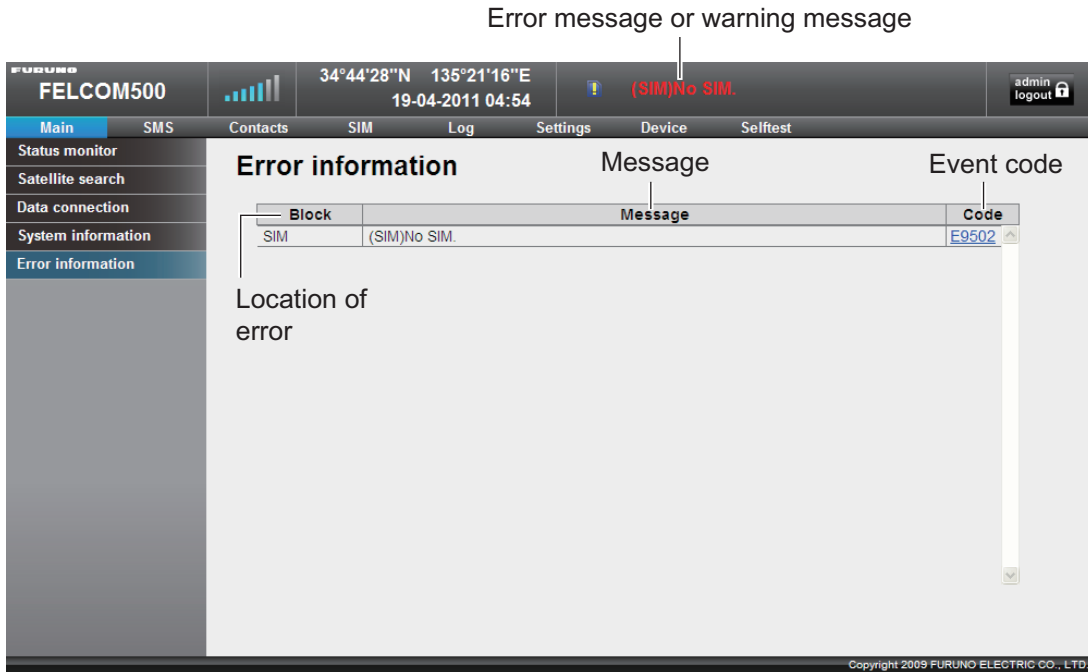

An Error message appears when a critical error occurs, and the unit can not function. A Warning message is displayed when an error occurs, and the unit can only operate with limited function.

### When an error/warning message appears

Click the event code to show the action to be taken. If the recommended action does not work, or a restart fails to restore normal operation, contact a FURUNO serviceman and report the Event detail.

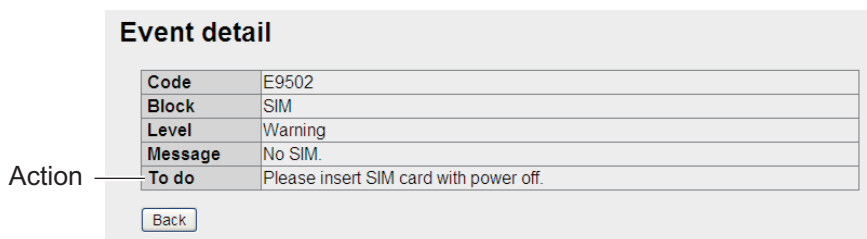

## 7.7 How to Restore Default Settings (Initialize)

You can restore default settings for the handset. Data is deleted when default settings are restored.

There are two methods to restore the handset to default settings:

Refer to the following table for detailed guide on what settings are included in the reset:

Item	Except con.	All settings
[Web top] menu: [1 Input URL] → [Input History]	No	No
[Web top] menu: [2 Favorites]	No	No
[Web top] menu: Cashed web page data	No	No
[Web top] menu: [4 Settings]	Yes	Yes
[SMS] menu: All messages in message box	No	No
[SMS] menu: [6 Settings]	No	Yes
System messages	No	No
All data in Contacts	No	No
[Settings] menu: [1 Basic]	Yes	Yes
[Settings] menu: [2 Network]	No	Yes
[Settings] menu: [3 SIP]	No	Yes
Operation Password	No	Yes

1. At the idle screen press the **Enter** key to open the Main menu.
2. Press **▼** to select [Settings], and press the **Enter** key.
3. Press **5** to select [Initialize]. The password input screen appears.
4. Press the **Enter** key.
5. Enter the operation password and press the **Enter** key.
6. Press **▼** to select [OK], and press the **Enter** key. The Initialize screen displays.
7. Press **▲** or **▼** to select the method, and press the **Enter** key.
8. Press **▲** to select [OK], and press the **Enter** key. When reset is finished, the message "Initialized." displays.

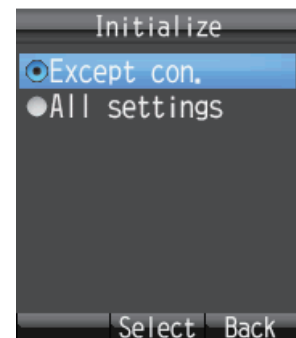

## 7.8 System Information

You can view system information on the System Information screen.

### How to view system information

1. Click [Main] in the menu bar.
2. Click [System information] to show the [System Information] screen.

Terminal information		BDE information	
IMEI	358422020002089	Software version	1650233-XX.XX
IMSI	901112114106120		
L-band range		ATB information	
ADE	Extended (Type XL)	Software version	44
BDE	Extended (Type XL)	Serial No.	0000000F
		HPA information	
		Firmware version	44
		Serial no.	0010

XX: Program version no.

### How to check the XL applicable unit

L-band range	
XL equipment	ADE: Extended (Type XL*), BDE: Extended (Type XL*)
non-XL equipment	Displays a code other than the above.

**Note 1:** \* is type of hardware.

**Note 2:** Refer to section 3.8 for how to display the version number of handset.

# APPENDIX 1 MENU TREE

## Handset Menu Tree

Default settings are presented in **bold** text.

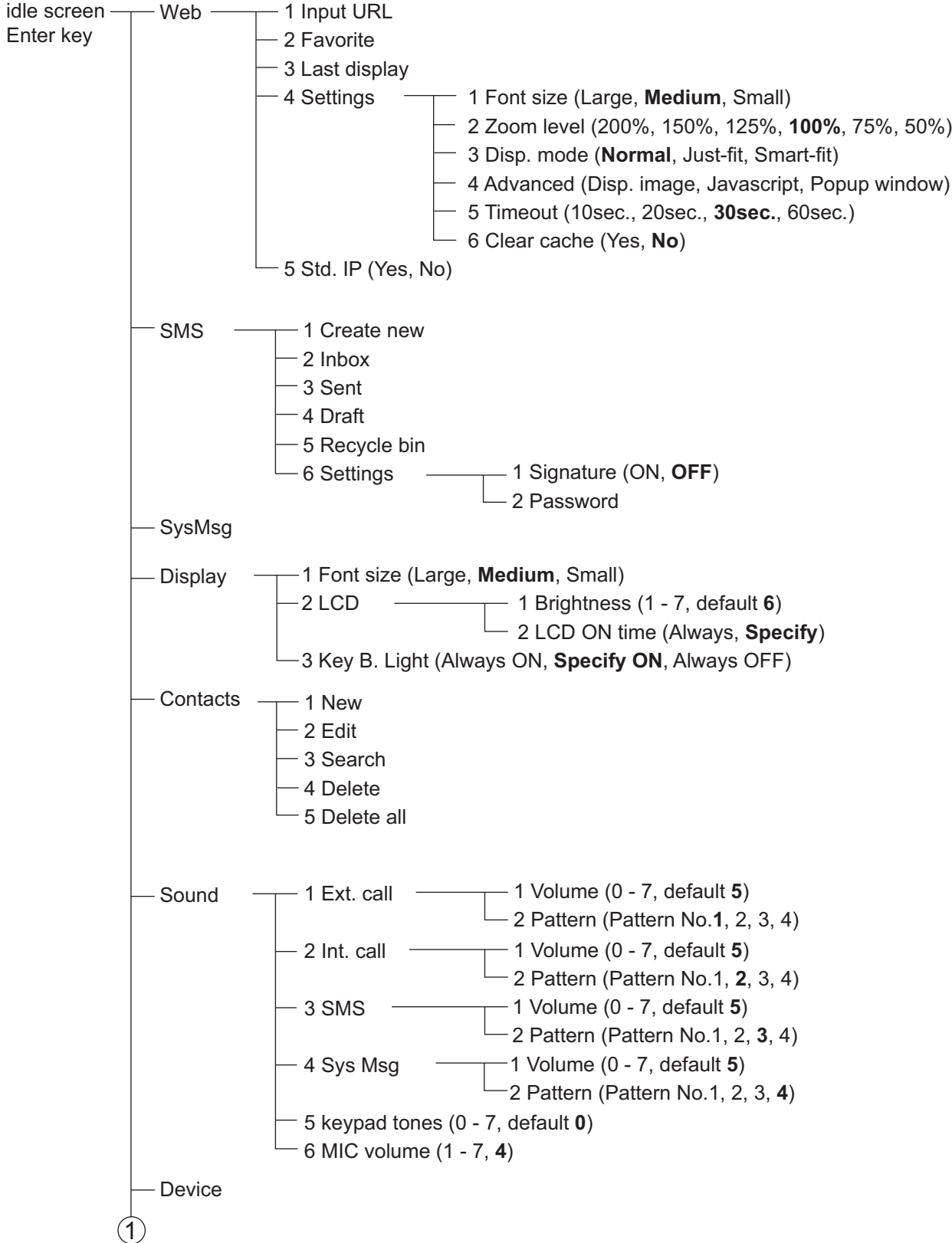

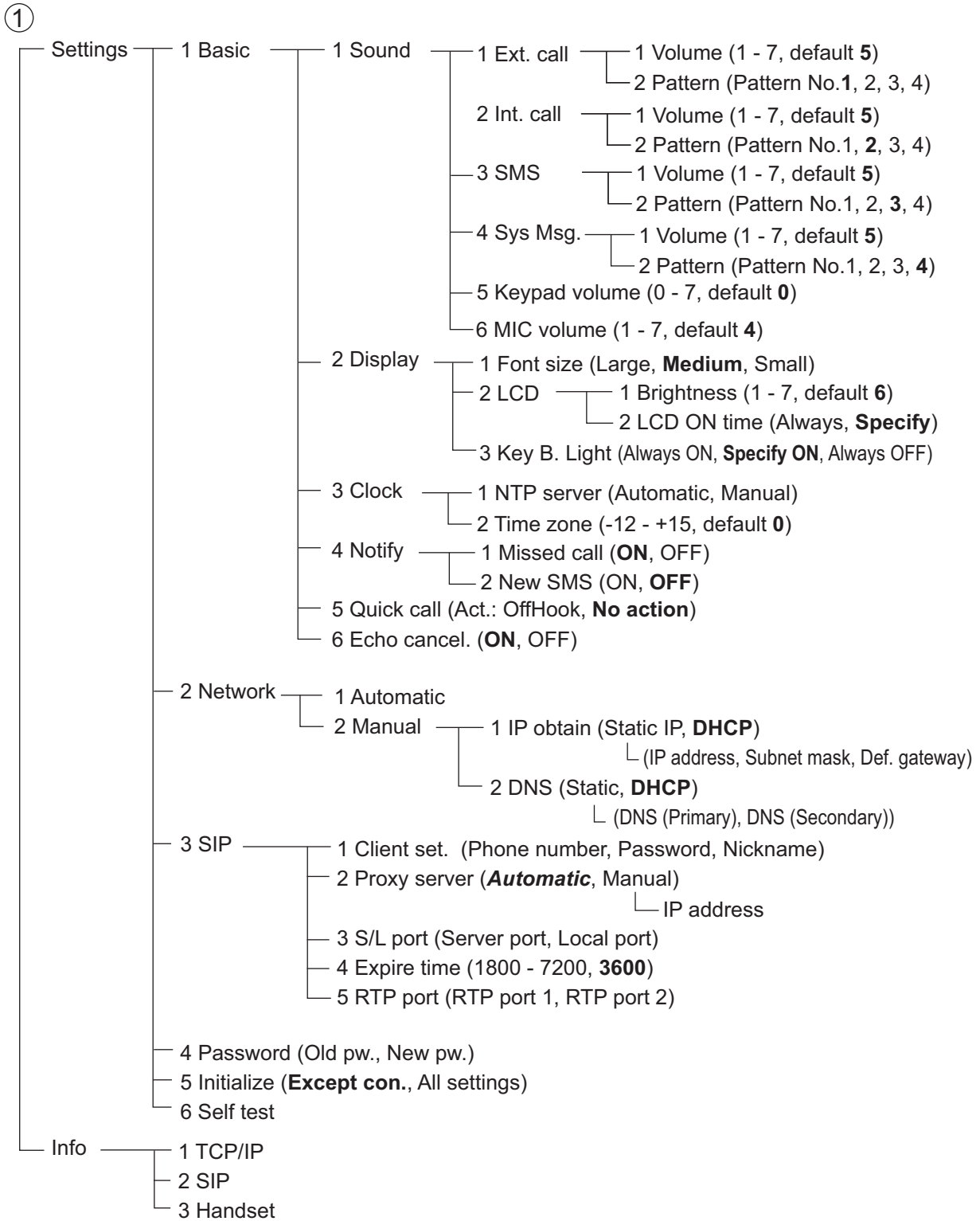



Web Menu Tree

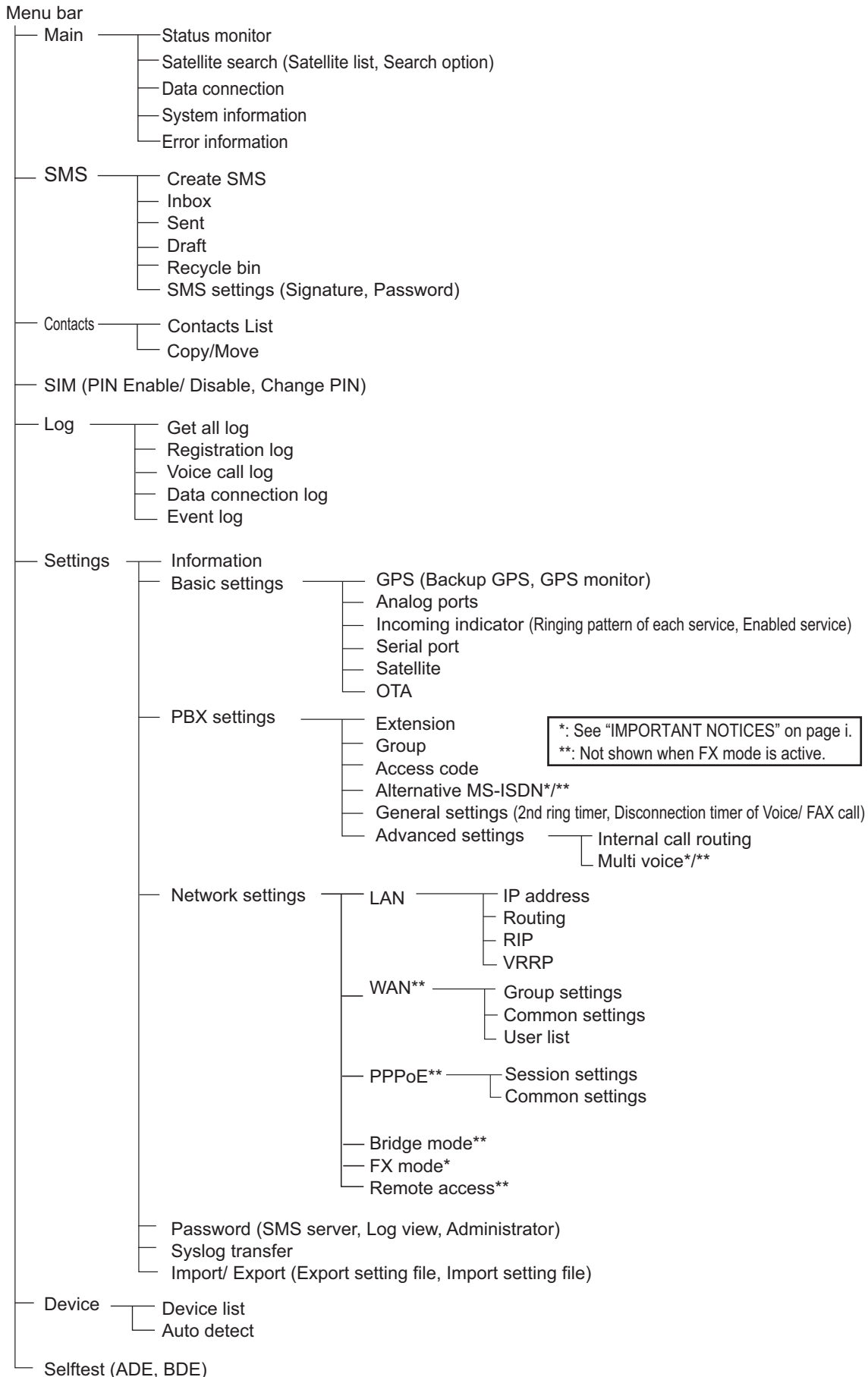

# APPENDIX 2 LIST OF TERMS AND ABBREVIATIONS

Term	Meaning
AMBE	Advanced Multi-Band Excitation. A proprietary speech coding standard developed by Digital Voice Systems Inc.
ADE	Above Deck Equipment. In this instance the antenna unit.
Air Interface	Wireless interface.
APN	Access Point Name. Destination name for packet communication.
ASK	Amplitude Shift Keying. The amplitude of an analog carrier signal varies in accordance with the bit stream (modulating signal), keeping frequency and phase constant.
ATB	Antenna Tracking Block. Mechanism inside the antenna unit which tracks the satellite.
BGAN	Broadband Global Area Network. A global satellite network with telephony, FAX and data transfer capability using portable terminals. The service is available with high-speed broadband data communication.
BOOTP	Bootstrap Protocol. A protocol where, on a TCP/IP network, a client machine automatically reads information from the server on startup.
CS	Circuit Switching. When calling with an analog or ISDN telephone, confirms that connection is made.
CSV	Comma Separated Value. Method of digital storage of data structured in a table of lists form, where each associated item (member) in a group in association with others is also separated by the commas of its set.
DHCP	Dynamic Host Configuration Protocol. A network application protocol used by devices (DHCP clients) to obtain configuration information for operation in an Internet Protocol network.
DHCP Lease	Length of time a DHCP client is allocated to maintain an IP connection to DHCP Server. Usually set by Administrator.
DMZ	DeMilitarized Zone. A physical or logical subnetwork that contains an organization's external services from a larger, untrusted network, usually the Internet.
DNS	Domain Name Service. The mechanism by which an IP address is assigned a name by the host.
DSP	Digital Signal Processor. A specialized microprocessor designed specifically for digital signal processing, generally in real-time computing.
FPGA	Field Programmable Gate Array. A semiconductor device that can be configured by the customer or designer after manufacturing.
FTP	File Transfer Protocol. Protocol used to send files on a TCP/IP network, internet, or intranet.
FX	Fleet Xpress. The FX service allows the use of GX (Global Xpress) and FBB (Fleet Broadband) services. FX also facilitates automatic switching between GX and FBB.
Gateway	Equipment or software used to relay network connections. The "doorway" of the network.
HPA	High Powered Amplifier.
ICCID	Integrated Circuit Card ID. The unique serial number, international number of the mobile user (IMSI), security authentication and ciphering information, temporary information related to the local network, a list of the services the user has access to and two passwords (PIN for usual use and PUK for unlocking).

<b>Term</b>	<b>Meaning</b>
ICMP	Internet Control Message Protocol. Protocol used to send error and warning messages. Allows networks and connected computers to mutually exchange status information.
IDENT	Identification Protocol. Protocol that sends information about the client to the server.
IMEI	International Mobile Equipment Identifier. A 15-digit number which indicates the model number, manufacturer, producer, and serial number of cell phones and data cards.
IMSI	International Mobile Subscriber Identity. Specific number assigned to individual SIM cards. Enables telephone communication.
IP filter	Software that can be configured to easily deny or allow access to a specific port or address.
IPSec	Internet Protocol Security. A protocol suite for securing Internet Protocol (IP) communications by authenticating and encrypting each IP packet of a data stream.
ISDN	Integrated Service Digital Network. A digital communications network that handles data integration for phones and faxes.
LAN	Local Area Network. Cable, Fibre-optic, etc. network that allows computers in the same geographical area to connect to each other and to other devices such as printers, servers, etc.
LaunchPad	BGAN application software to control devices in the system. CD-ROM supplied by Inmarsat.
MAC address	Media Access Control address. Unique number that identifies each computer on the network. Consists of 6 by 16 decimals.
Metric	The criteria used by the router to select the optimal route.
MS-ISDN	Mobile Subscriber ISDN Number.
NBT	NetBIOS over TCP/IP. A networking protocol that allows legacy computer applications relying on the NetBIOS API to be used on modern TCP/IP networks.
nslookup	A command used in troubleshooting DNS service.
NTP	Network Time protocol. A protocol which correctly synchronizes the clock to correct time with the equipment.
OTA	Over The Air. A term meaning wireless communication.
PBX	Private Branch eXchange. A telephone exchange that serves a particular business or office, as opposed to one that a common carrier or telephone company operates for many businesses or for the general public.
PDP	Packet Data Protocol. A PDP offers a pack data connection over which the UE and network can exchange IP packets.
PIN	Personal Identification Number. The SIM card identification number.
ping	Confirms if computers and networks are connected.
PPPoE	Point-to-Point protocol over Ethernet. A protocol for using the PPP function via Ethernet.
PPTP	Point-to-Point Tunneling Protocol. A method for implementing virtual private networks. PPTP does not provide confidentiality or encryption; It relies on the protocol being tunneled to provide privacy.
Proxy server	A server that acts as a go-between for requests from clients seeking resources from other servers.
PS	Packet Switching. A method of communication that separates data into small units (packets) and sends them individually.
PUK	PIN Unblocked Key. If the PIN is entered incorrectly 3 times the SIM card is blocked. Use the PUK code to unblock the SIM.
RDI	Restricted Digital Information. ISDN terminology for information or data that is restricted.

APPENDIX 2 LIST OF TERMS AND ABBREVIATIONS

Term	Meaning
RIP	Routing Protocol Information. A routing protocol for UDP/IP. Determines the shortest route to reach the network by calculating the path to the dynamic host based on the number of hops through routers.
RTP	Real-time Transport Protocol. A standardized packet format for delivering audio and video over the Internet.
RSSI	Received Signal Strength Indicator. Measures the strength of the wireless communication device.
SIM	Subscriber Identity Module. An IC card that stores the registered users subscriber number, phone number and information. When inserted into a terminal, the terminal operates on this information.
SIP	Session Initiation Protocol. A protocol for converting multimedia data into packets over an IP network. A standardized method of audio and video coding.
SIP server	DNS server that acts as a proxy for each domain name based on location of each domain.
SMS	Short Message Service. A method of sending short messages over mobile devices.
Streaming	A method transmitting audio, visual and multimedia where the data is transmitted and played back simultaneously.
UDI	Unrestricted Digital Information. ISDN terminology for the transmission capacity of data, video conferences, and G4 fax machines.
UPnP	Universal Plug and Play. Network equipment, software and hardware that provides compatibility between peripherals and network architecture.
URL	Uniform Resource Locator. Specifies where an identified resource is available and the mechanism for retrieving it. In popular language, a URL is also referred to as a Web address.
User Account	A character string that defines individual user settings on a computer. Generally in the form of a user name and password.
VPN	Virtual Private Network. A computer network in which some of the links between nodes are carried by open connections or virtual circuits in some larger networks (such as the Internet), as opposed to running across a single private network.
VRRP	Virtual Router Redundancy Protocol. A router multiplexing protocol. Two or more routers are configured as a default gateway. One router will automatically take over if the other router is faulty.
WAN	Wide Area Network. Using a telephone line or dedicated line two connect two or more computers in a geographically different location.

# APPENDIX 3 PARTS LIST, ARRANGEMENT

This equipment contains complex modules in which fault diagnosis and repair down to the component level is not practical (IMO A,694(17)/8.3.1). Only some discrete components are used. FURUNO Electric Co., Ltd. believes identifying these components is of no use for shipborne maintenance; therefore, they are not listed in the manual. Major modules can be located in Parts Location.

Unit	Printed Circuit Board	Code No.
FB-1250 (FELCOM 250)	SP-2713, GPS ASSY	000-173-443-10
	SP-2707, HPA UNIT	000-173-437-10
	SP-2712, INTERFACE ASSY	000-173-442-10
	SP-2701, ATB+LNA Module	000-173-431-10
FB-1500 (FELCOM 500)	SP-2201 ATB+LNA ASSY	001-083-800
	SP-2204, HPA UNIT	001-083-830
	SP-2227, GPS ASSY	001-084-630
	SP-2228, INTERFACE ASSY	001-084-640
FB-2000	16P0266(LF), POWER PCB	001-069-640
	16P0277(LF), PANEL PCB	001-069-690
	16P0274A(LF), MODEM PCB	001-069-660
	16P0275(LF), IF PCB	001-069-670
	16P0273(LF), HUB PCB	001-069-650
FB-8000	16P0259(LF), HANDSET PCB	001-069-740
FB-3000	16P0270(LF), INCOM. INDI PCB	001-069-620

APPENDIX 3 PARTS LIST, ARRANGEMENT

Parts Location

**FB-1250 (FELCOM 250)**

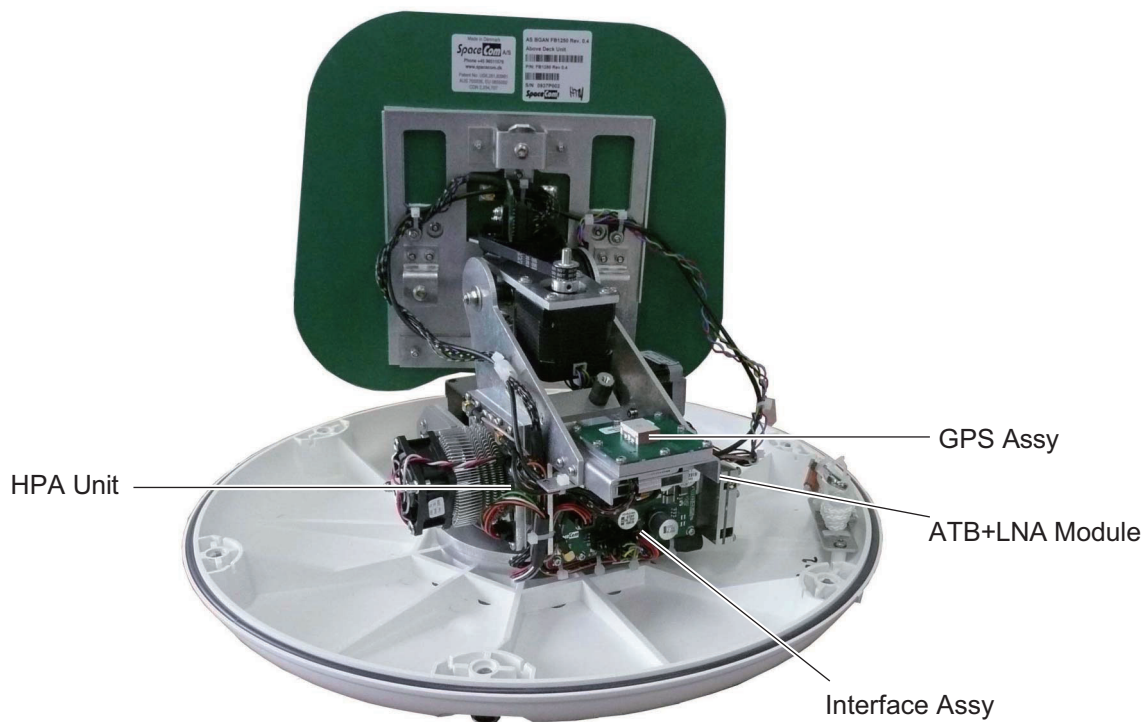

**FB-1500 (FELCOM 500)**

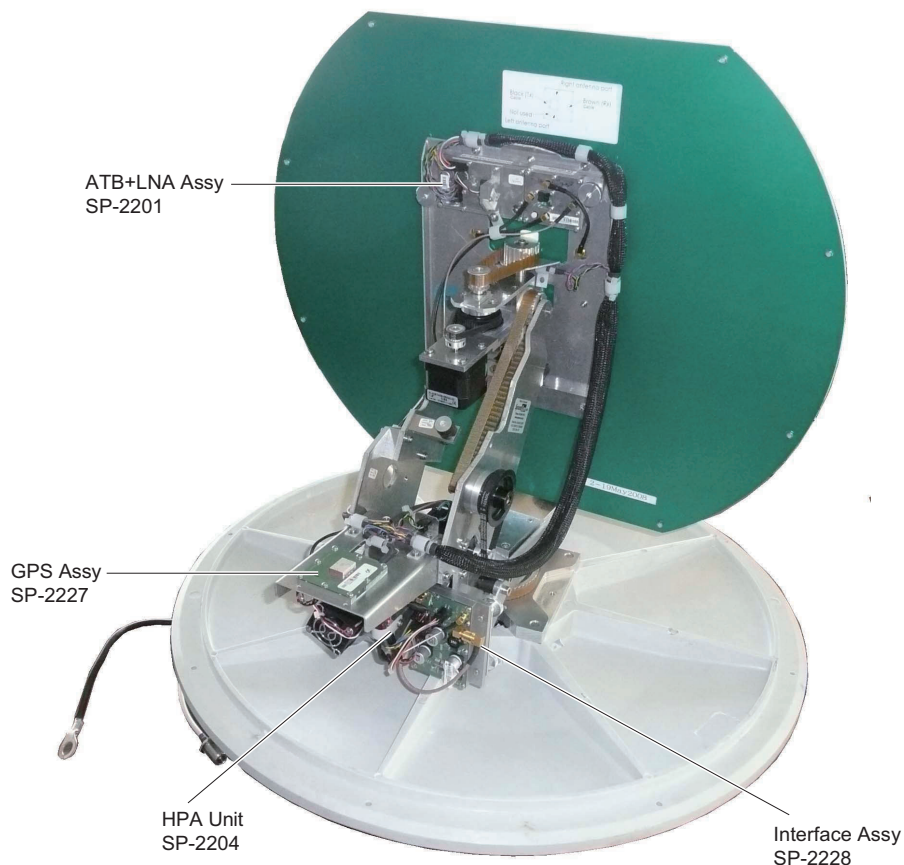

**AP-8**

FB-2000

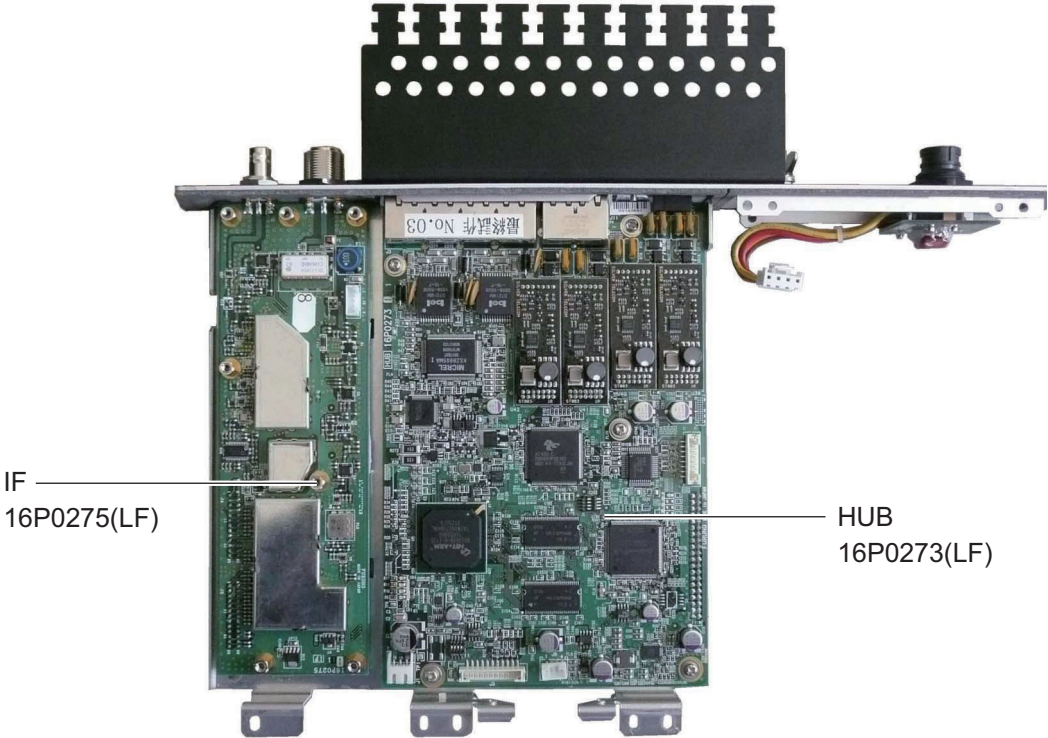
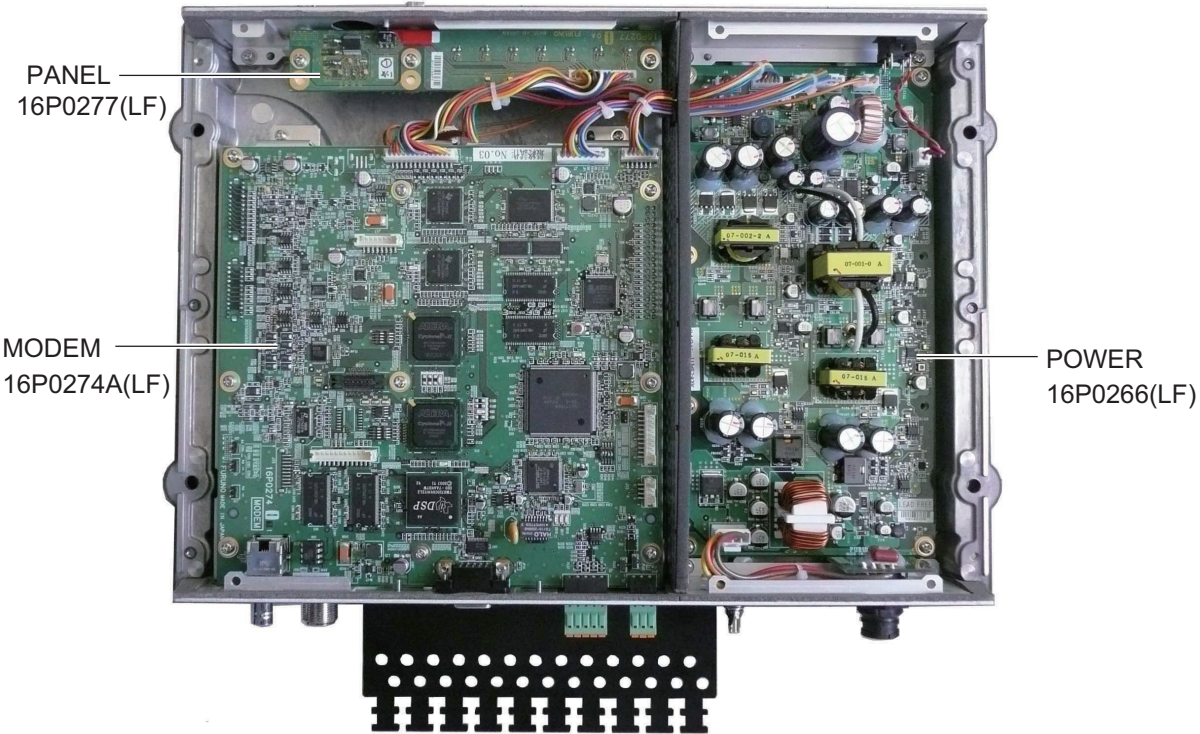

APPENDIX 3 PARTS LIST, ARRANGEMENT

FB-8000



HANDSET  
16P0259(LF)

FB-3000

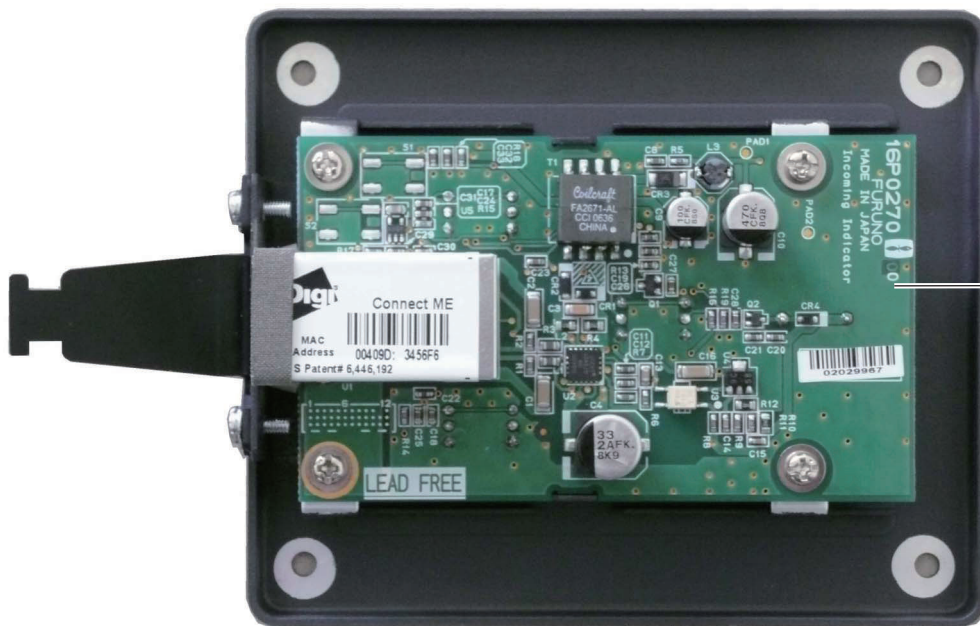

INCOM. INDI  
16P0270(LF)

AP-10



**SPECIFICATIONS OF INMARSAT FLEETBROADBAND  
FELCOM 250/500**

**1 GENERAL**

- 1.1 Transmit frequency 1626.5 to 1660.5 MHz  
(includes 1668.0 to 1675.0 MHz for XL equipment)
- 1.2 Receiving frequency 1525.0 to 1559.0 MHz  
(includes 1518.0 to 1525.0 MHz for XL equipment)
- 1.3 Channel interval 1.25 kHz
- 1.4 G/T FELCOM250: Better than -15.5dB/K  
FELCOM500: Better than -7dB/K
- 1.5 EIRP FELCOM250: 15.1 dBW, FELCOM500:22 dBW

**2 ANTENNA UNIT**

- 2.1 Antenna type Patch array antenna
- 2.2 Gain FELCOM250: Greater than 11.0dBi,  
FELCOM500: Greater than 17.0dBi
- 2.3 Axial ratio FELCOM250: Less than 4.0dB, FELCOM500: Less than 2.0dB
- 2.4 Antenna beam width FELCOM250: 40° approx. (at -3 dB)  
FELCOM500: 22° approx. (at -3 dB)
- 2.5 Stabilization Three-axis control
- 2.6 Positioning Az: 0° to 360°, El: 5° to 90°
- 2.7 Position accuracy Within 0.6dB (95% time)
- 2.8 Tracking Electrical beam tracking system

**3 COMMUNICATION UNIT**

- 3.1 Communication services
    - Voice 4 kbps AMBE+2 or ISDN3.1 kHz audio\*
    - Data FELCOM250: Standard IP 284 kbps (RX, best effort)  
FELCOM500: ISDN UDI/RDI 432 kbps (RX, best effort)
    - Short message service Up to 160 characters
    - Facsimile Group 3 facsimile via 3.1 kHz audio\*
  - 3.2 Modulation QPSK, 16QAM
- \*: ISDN 3.1kHz audio and facsimile are used at satellite angle 20° or more (for FELCOM250 only)

**4 INTERFACE**

- 4.1 Ethernet 4 ports, 10base-T or 100base-TX, PSE class 0 (total up to 30.8 W)
- 4.2 Analog telephone/telefax 4 ports
- 4.3 RS-232C 1 port
- 4.4 Output alarm 1 port, contact closure (normal close), 400V, 120 mA max.
- 4.5 Navigation data input 1 port, IEC61162-1
- 4.6 L-band output 1 port
- 4.7 SIM card slot 1

**5 POWER SUPPLY**

- 5.1 Communication unit 12-24 VDC: 9.2-4.6 A (transmit), 2.0-1.0 A (receive)
- 5.2 Handset PD class 2, 5 W or less
- 5.3 Incoming indicator PD class 1, 2 W or less
- 5.4 AC/DC power supply unit (PR-240, option)  
100-115/200-240 VAC, 1 phase, 50/60Hz

**6 ENVIRONMENTAL CONDITION**

- 6.1 Ambient temperature
  - Exposed equipment: -25°C to +55°C (storage: -40°C to +70°C)
  - Protected equipment: -25°C to +55°C
- 6.2 Relative humidity 95% at 40°C
- 6.3 Degree of protection
  - Antenna unit IP56
  - Communication unit IP22 (tabletop mount with a connector cover and grommets)
  - Handset IP22 (cradle: IPX0)
  - Incoming indicator IP22
  - Incoming bell IP20 (IP22: option)
- 6.4 Vibration IEC 60945
- 6.5 Motion Roll:  $\pm 30^\circ/8s$ , Pitch:  $\pm 10^\circ/6s$ , Yaw:  $\pm 8^\circ/50s$ , Rotation:  $6^\circ/s$ ,  
Speed: 30 kn

**7 UNIT COLOR**

- 7.1 Antenna unit N9.5
- 7.2 Communication unit N2.5
- 7.3 Handset/ cradle N2.5
- 7.4 Incoming indicator N2.5
- 7.5 Incoming bell N2.5

# INDEX

---

## A

- Access code ..... 6-3, 6-6
- Administrator password
  - changing of ..... 6-44
  - entry of ..... 6-1
- Answer
  - answer call during conversation ..... 2-6
  - receive a call ..... 2-6

## C

- Call forward ..... 2-7
- Common settings screen ..... 6-23, 6-31
- Communication unit
  - front panel ..... 1-1
  - led lamp guide ..... 7-3
  - power on/off ..... 1-4
- Connection ..... 6-18, 6-27
- Contact
  - add new contact on handset ..... 2-8
  - save number from history ..... 2-9
- Contacts
  - add a new handset contact ..... 2-8
  - arrange contacts in web software ..... 5-10
  - call from contacts ..... 2-4
  - delete contact on handset ..... 2-11
  - delete contacts in web software ..... 5-11
  - edit contact on handset ..... 2-11
  - edit contacts in web software ..... 5-11
  - save contact in web software ..... 5-9
  - save number from history ..... 2-9
  - save sender on handset ..... 2-21
  - search for contact in web software ..... 5-10
  - search handset contacts ..... 2-10

## D

- Device list
  - detect devices automatically ..... 6-46
  - manually register a device ..... 6-48
- DNS filter ..... 6-19, 6-28

## E

- Event log ..... 5-29
- External devices
  - fax-2840 fax ..... 4-1
  - fb-3000 incoming indicator ..... 4-1

## F

- Favorite
  - add url to favorite ..... 2-32
  - delete url from favorite ..... 2-33

## H

- Handset
  - call and message notification settings... 3-13
  - change font size ..... 3-3
  - change operation password ..... 3-18

- controls ..... 1-1
- device list ..... 3-19
- echo canceller ..... 3-14
- edit text ..... 1-10
- idle screen ..... 1-6
- input text ..... 1-9
- keypad backlight ..... 3-5
- lcd brightness and backlight ..... 3-4
- main menu ..... 1-7
- make a call ..... 2-1
- network settings ..... 3-15
- quick offhook ..... 3-14
- screen layout ..... 1-6
- set clock ..... 3-11
- set notification volume and ring pattern ... 3-1
- show tcp/ip, sip and software information.... 3-20
- sip settings ..... 3-17
- sound menu overview ..... 3-1
- system messages overview ..... 3-19
- turn keypad tones on/off ..... 3-2

## History

- call from history list ..... 2-3
- sub menu ..... 2-4

## I

- Internal call routing ..... 6-9
- Internet
  - view a webpage on handset ..... 2-27
- Internet via PPPoE ..... 6-39
- IP filter ..... 6-29

## L

- Log
  - send log ..... 6-45
  - view data communication log ..... 5-27
  - view registration log ..... 5-24

## M

- Manual satellite search ..... 5-22
- Microphone volume adjust ..... 3-2

## N

- Network settings
  - wan settings ..... 6-14

## O

- Outside call restrictions ..... 6-3

## P

- Password
  - overview ..... 1-13
- PIN code
  - locked ..... 1-5
- PPPoE
  - editing ..... 6-26, 6-27
  - password ..... 6-25
  - settings ..... 6-24

## INDEX

Put call on hold .....2-5

### **R**

Ring duration time .....6-8

### **S**

#### Self test

communication unit and antenna self test ...7-7

error/warning messages.....7-8

handset self test.....7-6

Session setting screen (PPPoE).... 6-26, 6-27

#### SIM

change pin code.....5-21

update sim card information.....5-21

#### Sim card

introduction.....1-3

#### SMS

access url and phone numbers within

messages .....2-24

call sender.....2-21

change sms password in web software .6-44

delete message from recycle bin in web

software.....5-17

delete messages in recycle bin on

handset .....2-19

draft messages on handset.....2-23

edit and re-send on handset .....2-22

enter password in web software.....5-13

forward message on handset.....2-20

handset login.....2-13

message boxes .....2-16

move message to recycle bin on

handset .....2-17

move messages from recycle bin in web

software.....5-17

move messages from recycle bin on

handset .....2-18

reply to sms on handset.....2-20

save sms password on handset.....3-7

send message in web software.....5-14

send message on handset.....2-14

send message to recycle bin in web

software.....5-16

set signature and password in web

software.....5-20

set signature on handset.....3-6

sort messages on handset.....2-17

view received message in web

software.....5-15

view received message on handset .....2-15

web software draft box .....5-19

web software sent box .....5-18

#### SMS password

changing.....6-44

System configuration .....x

### **T**

TCP/IP ..... 6-17, 6-26

Timeout.....6-8

#### Troubleshooting

change the fuse.....7-2

maintenance.....7-1

troubleshooting procedures.....7-4

### **U**

User List .....6-23

### **V**

Volume adjust .....2-5

### **W**

#### Web

change handset browser font size .....3-7

clear cache.....3-10

connect/disconnect to internet in web

software.....5-6

connect/disconnect to internet on

handset .....2-26

handset advanced settings .....3-9

handset display mode .....3-8

handset display zoom .....3-8

handset timeout.....3-10

handset web submenu .....2-31

settings menu.....3-7

view a web page on handset.....2-27

#### Web software

administrator login.....6-1

group register .....6-5

how to open/close web software .....5-1

introduction.....5-1

register extension numbers.....6-2

screen explanation .....5-2

status monitor.....5-4

view system information.....7-10

## Declaration of Conformity

### [FELCOM250/FELCOM500]

Bulgarian (BG)	<p>С настоящото Furuno Electric Co., Ltd. декларира, че гореспоменат тип радиосъоръжение е в съответствие с Директива 2014/53/ЕС.</p> <p>Цялостният текст на ЕС декларацията за съответствие може да се намери на следния интернет адрес:</p>
Spanish (ES)	<p>Por la presente, Furuno Electric Co., Ltd. declara que el tipo de equipo radioeléctrico arriba mencionado es conforme con la Directiva 2014/53/UE.</p> <p>El texto completo de la declaración UE de conformidad está disponible en la dirección Internet siguiente:</p>
Czech (CS)	<p>Tímto Furuno Electric Co., Ltd. prohlašuje, že výše zmíněné typ rádiového zařízení je v souladu se směrnicí 2014/53/EU.</p> <p>Úplné znění EU prohlášení o shodě je k dispozici na této internetové adrese:</p>
Danish (DA)	<p>Hermed erklærer Furuno Electric Co., Ltd., at ovennævnte radioudstyr er i overensstemmelse med direktiv 2014/53/EU.</p> <p>EU-overensstemmelseserklæringens fulde tekst kan findes på følgende internetadresse:</p>
German (DE)	<p>Hiermit erkläre die Furuno Electric Co., Ltd., dass der oben genannte Funkanlagentyp der Richtlinie 2014/53/EU entspricht.</p> <p>Der vollständige Text der EU-Konformitätserklärung ist unter der folgenden Internetadresse verfügbar:</p>
Estonian (ET)	<p>Käesolevaga deklareerib Furuno Electric Co., Ltd., et ülalmainitud raadioseadme tüüp vastab direktiivi 2014/53/EL nõuetele.</p> <p>ELi vastavusdeklaratsiooni täielik tekst on kättesaadav järgmisel internetiaadressil:</p>
Greek (EL)	<p>Με την παρούσα η Furuno Electric Co., Ltd., δηλώνει ότι ο προαναφερθέντας ραδιοεξοπλισμός πληροί την οδηγία 2014/53/ΕΕ.</p> <p>Το πλήρες κείμενο της δήλωσης συμμόρφωσης ΕΕ διατίθεται στην ακόλουθη ιστοσελίδα στο διαδίκτυο:</p>
English (EN)	<p>Hereby, Furuno Electric Co., Ltd. declares that the above-mentioned radio equipment type is in compliance with Directive 2014/53/EU.</p> <p>The full text of the EU declaration of conformity is available at the following internet address:</p>
French (FR)	<p>Le soussigné, Furuno Electric Co., Ltd., déclare que l'équipement radioélectrique du type mentionné ci-dessus est conforme à la directive 2014/53/UE.</p> <p>Le texte complet de la déclaration UE de conformité est disponible à l'adresse internet suivante:</p>
Croatian (HR)	<p>Furuno Electric Co., Ltd. ovime izjavljuje da je gore rečeno radijska oprema tipa u skladu s Direktivom 2014/53/EU.</p> <p>Cjeloviti tekst EU izjave o sukladnosti dostupan je na sljedećoj internetskoj adresi:</p>
Italian (IT)	<p>Il fabbricante, Furuno Electric Co., Ltd., dichiara che il tipo di apparecchiatura radio menzionato sopra è conforme alla direttiva 2014/53/UE.</p> <p>Il testo completo della dichiarazione di conformità UE è disponibile al seguente indirizzo Internet:</p>
Latvian (LV)	<p>Ar šo Furuno Electric Co., Ltd. deklarē, ka augstāk minēts radioiekārta atbilst Direktīvai 2014/53/ES.</p> <p>Pilns ES atbilstības deklarācijas teksts ir pieejams šādā interneta vietnē:</p>

Lithuanian (LT)	Aš, Furuno Electric Co., Ltd., patvirtinu, kad pirmiau minėta radijo įrenginių tipas atitinka Direktyvą 2014/53/ES. Visas ES atitikties deklaracijos tekstas prieinamas šiuo interneto adresu:
Hungarian (HU)	Furuno Electric Co., Ltd. igazolja, hogy fent említett típusú rádióberendezés megfelel a 2014/53/EU irányelvnek. Az EU-megfelelőségi nyilatkozat teljes szövege elérhető a következő internetes címen:
Maltese (MT)	B'dan, Furuno Electric Co., Ltd., niddikjara li msemmija hawn fuq-tip ta' tagħmir tar-radju huwa konformi mad-Direttiva 2014/53/UE. It-test kollu tad-dikjarazzjoni ta' konformità tal-UE huwa disponibbli f'dan l-indirizz tal-Internet li ġej:
Dutch (NL)	Hierbij verklaar ik, Furuno Electric Co., Ltd., dat het hierboven genoemde type radioapparaat conform is met Richtlijn 2014/53/EU. De volledige tekst van de EU-conformiteitsverklaring kan worden geraadpleegd op het volgende internetadres:
Polish (PL)	Furuno Electric Co., Ltd. niniejszym oświadcza, że wyżej wymieniony typ urządzenia radiowego jest zgodny z dyrektywą 2014/53/UE. Pełny tekst deklaracji zgodności UE jest dostępny pod następującym adresem internetowym:
Portuguese (PT)	O(a) abaixo assinado(a) Furuno Electric Co., Ltd. declara que o mencionado acima tipo de equipamento de rádio está em conformidade com a Diretiva 2014/53/UE. O texto integral da declaração de conformidade está disponível no seguinte endereço de Internet:
Romanian (RO)	Prin prezenta, Furuno Electric Co., Ltd. declară că menționat mai sus tipul de echipamente radio este în conformitate cu Directiva 2014/53/UE. Textul integral al declarației UE de conformitate este disponibil la următoarea adresă internet:
Slovak (SK)	Furuno Electric Co., Ltd. týmto vyhlasuje, že vyššie spomínané rádiové zariadenie typu je v súlade so smernicou 2014/53/EÚ. Úplné EÚ vyhlásenie o zhode je k dispozícii na tejto internetovej adrese:
Slovenian (SL)	Furuno Electric Co., Ltd. potrjuje, da je zgoraj omenjeno tip radijske opreme skladen z Direktivo 2014/53/EU. Celotno besedilo izjave EU o skladnosti je na voljo na naslednjem spletnem naslovu:
Finnish (FI)	Furuno Electric Co., Ltd. vakuuttaa, että yllä mainittu radiolaitetyyppi on direktiivin 2014/53/EU mukainen. EU-vaatimustenmukaisuusvakuutuksen täysimittainen teksti on saatavilla seuraavassa internetosoitteessa:
Swedish (SV)	Härmed försäkrar Furuno Electric Co., Ltd. att ovan nämnda typ av radioutrustning överensstämmer med direktiv 2014/53/EU. Den fullständiga texten till EU-försäkran om överensstämmelse finns på följande webbadress:

## Online Resource

[http://www.furuno.com/en/support/red\\_doc](http://www.furuno.com/en/support/red_doc)